



Department of  
Education



Book 2

# First Steps in Mathematics

## Measurement

- Indirect Measure
  - Estimate

*Improving the mathematics  
outcomes of students*

First steps in Mathematics: Measurement - Book 2  
Indirect measure; Estimate

© Department of Education WA 2013

First published in 2005

Revised edition

ISBN: 978-0-7307-4486-3

SCIS: 1593625



# Diagnostic Map: Measurement

## What is the Diagnostic Map for Measurement?

How students currently think about measurement attributes and units will influence how they respond to the activities provided for them, and hence what they are able to learn from them. As students' thinking about measurement develops, it goes through a series of characteristic phases. Recognising these common patterns of thinking should help you to interpret students' responses to activities, to understand why they seem to be able to do some things and not others, and also why some students may be having difficulty in achieving certain outcomes while others are not. It should also help you to provide the challenges students need to move their thinking forward, to refine their half-formed ideas, to overcome any misconceptions they might have and hence to achieve the outcomes.

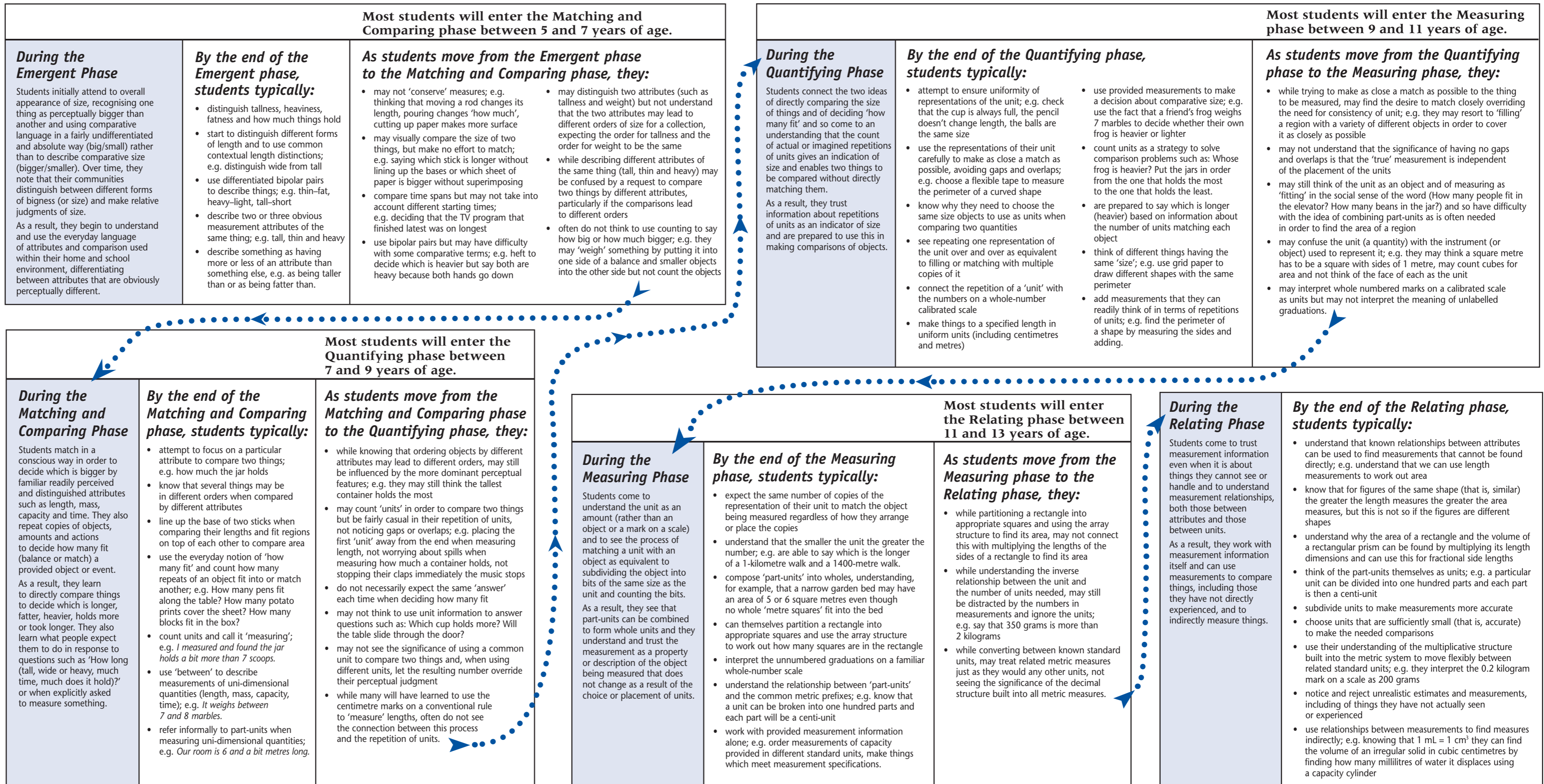

# Contents

<b>Foreword</b>	<b>v</b>
<b>CHAPTER 1</b>	
What Are the Features of This Resource Book?	<b>1</b>
<b>CHAPTER 2</b>	
The Measurement Outcomes	<b>6</b>
<b>CHAPTER 3</b>	
Indirect Measure	<b>9</b>
<b>CHAPTER 4</b>	
Estimate	<b>69</b>
<b>Appendix</b>	
Classroom Plan Pro Forma	<b>105</b>
<b>Bibliography</b>	<b>106</b>



## Foreword

The *First Steps in Mathematics* Resource Books and professional development program are designed to help teachers to plan, implement and evaluate the mathematics curriculum they provide for their students. The series describes the key mathematical ideas students need to understand in order to achieve the mathematics outcomes described in the Western Australian *Curriculum Framework* (1998).

Each Resource Book is based on five years of research by a team of teachers from the Department of Education and Training, and tertiary consultants led by Professor Sue Willis at Murdoch University. The *First Steps in Mathematics* project team conducted an extensive review of national and international research literature, which revealed gaps in the field of knowledge about students' learning in mathematics.

Using tasks designed to replicate those in the research literature, team members interviewed students in diverse locations. Analysis of the data obtained from these interviews identified characteristic phases in the development of students' thinking about major mathematical concepts. The Diagnostic Maps—which appear in the Resource Books for Number, Measurement, Space, and Chance and Data—describe these phases of development.

It has never been more important to teach mathematics well. Globalisation and the increasing use of technology have created changing demands for the application of mathematics in all aspects of our lives. Teaching mathematics well to all students requires a high level of understanding of teaching and learning in mathematics and of mathematics itself. The *First Steps in Mathematics* series and professional development program will enhance teachers' capacity to decide how best to help all of their students achieve the mathematics outcomes.

The commitment and persistence of many teachers and officers of the Department of Education and Training, who contributed to the research and development of *First Steps in Mathematics*, is acknowledged and appreciated. Their efforts have resulted in an outstanding resource for teachers. I commend this series to you.



**Paul Albert**  
**Director General**  
**Department of Education and Training**  
**Western Australia**



## CHAPTER 1

# What Are the Features of This Resource Book?

The *First Steps in Mathematics: Measurement* Resource Books will help teachers to diagnose, plan, implement and judge the effectiveness of the teaching and learning experiences they provide for their students. *First Steps in Mathematics: Measurement* has two Resource Books. The first book examines the outcomes relating to Understand Units and Direct Measure. The second book examines those relating to Indirect Measure and Estimate.

This Resource Book includes the following elements.

- Diagnostic Map
- Mathematics Outcomes
- Levels of Achievement
- Pointers
- Key Understandings
- Sample Learning Activities
- Sample Lessons
- 'Did You Know?' sections
- Background Notes





## Diagnostic Maps

The purpose of the Diagnostic Maps is to help teachers:

- understand why students seem to be able to do some things and not others
- realise why some students may be experiencing difficulty while others are not
- indicate the challenges students need to move their thinking forward, to refine their preconceptions, overcome any misconceptions, and so achieve the outcomes
- interpret their students' responses to activities.

Each map includes key indications and consequences of students' understanding and growth. This information is crucial for teachers making judgments about their students' level of understanding of mathematics. It enhances teachers' judgments about what to teach, to whom and when to teach it.

### *Using the Diagnostic Maps*

The Diagnostic Maps are intended to assist teachers as they plan their mathematics curriculum. The Diagnostic Maps describe the characteristic phases in the development of students' thinking about the major concepts in each set of outcomes. The descriptions of the phases help teachers make judgments about students' understandings of the mathematical concepts.

The text in the shaded sections of each map describes students' major preoccupations, or focus, *during* that phase of thinking about the mathematics strand.

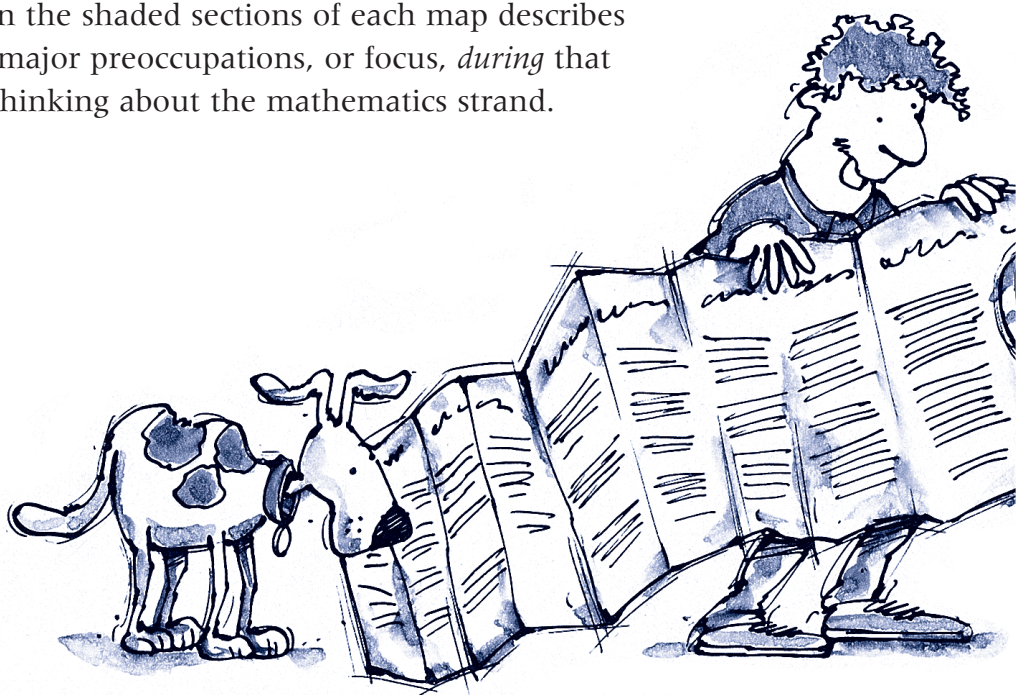

The 'By the end' section of each phase provides examples of what students typically think and are able to do as a result of having worked through the phase.

The achievements in the 'By the end' section should be read in conjunction with the 'As students move from' section. The 'As students move from' section includes the preconceptions, partial conceptions and misconceptions that students may have developed along the way. These provide the learning challenges for the next phase.

Together, the 'By the end' and 'As students move from' sections illustrate that while students might have developed a range of important understandings as they passed through the phase, they might also have developed some unconventional or unhelpful ideas at the same time. Both of these sections of the Diagnostic Map are intended as a useful guide only.

## Mathematics Outcomes

The mathematics outcomes indicate what students are expected to know, understand and be able to do as a result of their learning experiences. The outcomes provide a framework for developing a mathematics curriculum that is taught to particular students in particular contexts. The outcomes for Measurement are located at the beginning of each section of the two Resource Books.



## Levels of Achievement

There are eight Levels of Achievement for each mathematics outcome. The *First Steps in Mathematics* Resource Books address Levels 1 to 5 of these outcomes because they cover the typical range of achievement in primary school.

The Levels of Achievement describe markers of progress towards full achievement of the outcomes. Each student's achievement in mathematics can be monitored and success judged against the Levels of Achievement.

As the phases of the Diagnostic Maps are developmental, and not age specific, the Levels of Achievement will provide teachers with descriptions of the expected progress that students will make every 18 to 20 months when given access to an appropriate curriculum.

## Pointers

Each Level of Achievement has a series of Pointers. They provide examples of what students might typically do if they have achieved a level. The Pointers help clarify the meaning of the mathematics outcome and the differences between the Levels of Achievement.

## Key Understandings

The Key Understandings are the cornerstone of the *First Steps in Mathematics* series. The Key Understandings:

- describe the mathematical ideas, or concepts, which students need to know in order to achieve the outcome
- explain how these mathematical ideas relate to the levels of achievement for the mathematics outcomes
- suggest what experiences teachers should plan for students so they achieve the outcome
- provide a basis for the recognition and assessment of what students already know and still need to know in order to progress
- indicate the emphasis of the curriculum at particular stages
- provide content and pedagogic advice to assist with planning the curriculum at the classroom and whole-school levels.

The number of Key Understandings for each mathematics outcome varies according to the number of 'big mathematical ideas' students need to achieve the outcome.

## Sample Learning Activities

For each Key Understanding, there are Sample Learning Activities that teachers could use to develop the mathematical ideas of the Key Understanding. The activities are organised into three broad groups.

- Beginning activities are suitable for Kindergarten to Year 3 students.
- Middle activities cater for Year 3 to Year 5 students.
- Later activities are designed for Year 5 to Year 7 students.

If students in the later years have not had enough prior experience, then teachers may need to select and adapt activities from earlier groups.

## Sample Lessons

The Sample Lessons illustrate some of the ways teachers can use the Sample Learning Activities for the Beginning, Middle and Later groups. The emphasis is on how teachers can focus students' attention on the mathematics during the learning activity.

## 'Did You Know?' Sections

For some of the Key Understandings, there are 'Did You Know?' sections. These sections highlight common understandings and misunderstandings that students have. Some 'Did You Know?' sections also suggest diagnostic activities that teachers may wish to try with their students.

## Background Notes

The Background Notes supplement the information provided in the Key Understandings. These notes are designed to help teachers develop a more in-depth knowledge of what is required as students achieve the mathematics outcomes.

The Background Notes are based on extensive research and are more detailed than the descriptions of the mathematical ideas in the Key Understandings. The content of the Background Notes varies. Sometimes, they describe how students learn specific mathematical ideas. Other notes explain the mathematics of some outcomes that may be new or unfamiliar to teachers.

## CHAPTER 2

# The Measurement Outcomes

The Measurement strand focuses on the basic principles of measurement: the range of measures in common use and the skills needed for everyday purposes. As a result of their learning, students will develop confidence and proficiency in using direct and indirect measurement and estimating skills to describe, compare, evaluate, plan and construct.

To achieve this, students require an understanding of the nature of the different physical attributes that can be measured and the way units are used to quantify amounts of such attributes to needed levels of accuracy. It also requires the ability and understandings needed to make informed judgments about measurements for a range of purposes and to calculate measurement indirectly using measurement relationships. Learning experiences should be provided that will enable students to understand units, directly and indirectly measure, and estimate measurements.

As a result of learning experiences, students should be able to achieve the following outcomes.

### **Understand Units**

Decide what needs to be measured by selecting what attributes to measure and what units to use.

### **Direct Measure**

Carry out measurements of length, capacity/volume, mass, area, time and angle to needed levels of accuracy.

### **Indirect Measure**

Select, interpret and combine measurements, measurement relationships and formulae to determine other measures indirectly.

### Estimate

Make sensible direct and indirect estimates of quantities and be alert to the reasonableness of measurements and results.

## Integrating the Outcomes

The outcomes suggested above for Measurement are each dealt with in a separate chapter. This is to emphasise the importance of each and the difference between them. For example, students need to learn about what attributes to measure and what units to use (Understand Units) as well as developing the skill to reliably and accurately use units to directly measure each of these attributes (Direct Measure). By paying separate and special attention to each outcome, teachers can make sure that both areas receive sufficient attention and that important ideas about each are drawn out of the learning experiences they provide.

This does not mean, however, that the ideas and skills underpinning each of the outcomes should be taught separately or that they will be learned separately. The outcomes are inextricably linked.

Consequently, many of the activities will provide opportunities for students to develop their ideas about more than one of the outcomes. This will help teachers to ensure that the significant mathematical ideas are drawn from the learning activities so that students achieve each of the outcomes for Measurement.

## A Snapshot of the Levels of Achievement in Measurement

Students should not always be expected to be at the same level of achievement for each of the outcomes in Measurement. Students vary, so some may progress more rapidly with several aspects of Measurement than others. Teaching and learning programs also vary and may, at times, inadvertently or deliberately emphasise some aspects of Measurement more than others.

Nevertheless, while the outcomes for Measurement are dealt with separately in these materials, they should be developing together and supporting each other, leading to an integrated set of concepts within students' heads.

The levels for each mathematics outcome indicate the typical things students are expected to do at the same time. Generally, students who have access to a curriculum that deals appropriately and

thoroughly with each of the outcomes reach a particular level at roughly the same time for each outcome in Measurement.

*A student has achieved a level of a **particular outcome** when he or she is able to do all the things described at that level consistently and autonomously over the range of common contexts or experiences.*

*A student has achieved a level of a **set of outcomes** when he or she consistently and autonomously produces work of the standard described over the full range of outcomes at that level.*

Judgment will be needed to decide whether a student has achieved a particular level. When mapping and reporting a student's long-term progress, a teacher has to find the specific outcome level or the level for the set of outcomes that best fits the student, in the knowledge that no description is likely to fit perfectly.

The Level Statements for Measurement are on pages 167 to 176 of *First Steps in Mathematics: Measurement, Understand Units, Direct Measure*.

## CHAPTER 3

# Indirect Measure

This chapter will support teachers in developing teaching and learning programs that relate to this outcome:

*Select, interpret and combine measurements, measurement relationships and formulae to determine other measures indirectly.*

### **Overall Description**

Indirect measurement is used when direct comparison or measurement of quantities is impossible, impractical or simply tedious. Students choose and use a range of methods of indirect measurement. They weigh a few pieces of fruit at a time and add the weights because their scales won't accommodate more than 500 grams. They predict when a video will finish by taking the time now and adding on the 'length' of the film. They may also use division or averaging to find measurements more accurate than their equipment allows; for example, measuring the thickness of a ream of paper in order to calculate the thickness of one sheet. They also use formulae for finding lengths, areas and volumes, scale and similarity; Pythagoras' theorem and trigonometric ratios for finding lengths and distances in three dimensional contexts; and rates and derived measures such as speed and density for calculating quantities.



Levels of Achievement	Pointers This will be evident when students:	
<p>Students have achieved Level 3 when they understand and measure perimeter directly and use straightforward arithmetic to determine perimeters, elapsed time and other measurements that cannot be obtained directly. Students also attend informally to scale when making and using plans, maps and models.</p>	<ul style="list-style-type: none"> <li>recognise practical situations in which they need to find the perimeter of a region</li> <li>find the perimeter of a polygon by measuring each side and adding the lengths</li> <li>add length, capacity and mass measurements in order to calculate total size; e.g. to measure out a kilogram of apples with a scale that only goes to 500 grams, weigh a few apples at a time and add</li> <li>estimate and calculate to work out about how long things took or will take</li> <li>work out the time a certain number of minutes or hours ago or ahead; e.g. to set the alarm on a watch for one half hour hence</li> </ul>	<p>and when students, for example:</p> <ul style="list-style-type: none"> <li>draw informal maps and plans that show a sense of scale, that is, look 'roughly right'</li> <li>show a sense of scale when producing or selecting objects for a purpose; e.g. when making a model school yard, attempt to make component parts that 'look right' in terms of relative size</li> <li>make models to a specified but informal scale; e.g. make a play dough car that is about the right size for the model garage</li> <li>use their informal understanding that maps and plans are drawn 'to scale' to make simple comparisons; e.g. <i>The river is further away than the road.</i></li> </ul>
<p>Students have achieved Level 4 when they understand relationships involving the perimeter of polygons, the area of regions based on squares and the volume of prisms based on cubes and use these for practical purposes.</p> <p>Students also understand and use scale factors involving small whole numbers and unit fractions for straightforward tasks, including to make figures and objects on grids and with cubes.</p>	<ul style="list-style-type: none"> <li>decide whether a shape is sufficiently close to rectangular so that adding adjacent sides and doubling will be a 'good enough' estimate of perimeter for the task at hand</li> <li>given a rectangle with whole number length sides, explain why multiplying the length by height gives the area; e.g. draw lines in a rectangle to show that 24 cm by 7 cm can be thought of as 7 strips of 24 square centimetres</li> <li>dissect a non-rectangular shape that is composed of squares (i.e. drawn on the lines of grid paper) into two or three rectangles in order to easily find the area without counting each square</li> <li>demonstrate that shapes made with squares may have different perimeters but equal areas and different areas but equal perimeters; e.g. make rectangles with an area of 24 squares but with different perimeters</li> <li>measure the volume of prisms that can be composed of cubes; e.g. count the cubes in one layer of a prism and multiply by the number of layers</li> </ul>	<p>and when students, for example:</p> <ul style="list-style-type: none"> <li>given a picture or object and a whole number or unit fraction scale factor, estimate the size of parts of the scaled version</li> <li>use a grid to enlarge/reduce a figure in a specified way; e.g. given a fish drawn on a square grid, draw one three times as long and three times as high</li> <li>use a grid to distort a figure in a specified way; e.g. given a figure drawn on a square grid, draw one three times as long but the same height</li> <li>understand that for the final figure to 'look the same shape' as the original, all lengths have to be scaled by the same amount</li> <li>make an arrangement of a small number of cubes, say five, and build an identical arrangement except that it is twice as high, wide and long</li> <li>predict the length of sloped segments on a figure when it has been enlarged e.g. <i>The fin of the fish will be twice as long.</i></li> </ul>
<p>Students have achieved Level 5 when they understand and apply directly length, area and volume relationships for shapes based on rectangles and rectangular prisms.</p> <p>Students also understand and use scale factors and the effect of scaling linear dimensions on lengths, areas and volumes of figures and objects produced on grids and with cubes.</p>	<ul style="list-style-type: none"> <li>multiply to calculate areas of rectangles and volume of prisms including where the sides are not described in whole numbers</li> <li>inspect the nets of various rectangular prisms and generate short cuts for finding their surface area</li> <li>demonstrate why all parallelograms on the same base and of the same height will have the same area; e.g. cut and rearrange parallelograms into rectangles of the same base and height</li> <li>demonstrate why all triangles on the same base and of the same height will have half the area of a rectangle of the same height; e.g. draw a rectangle around a triangle on the same base of height and shade to show that the triangle is half the area</li> <li>demonstrate suitable dissections of complex shapes into several rectangles or rectangular prisms for each of which the dimensions and hence the area and volume can be determined</li> </ul>	<p>and when students, for example:</p> <ul style="list-style-type: none"> <li>given two different-sized copies of a model or picture, make appropriate measurements and work out the scale; e.g. measure matching parts of two different-sized photocopies of their hand</li> <li>given a model or picture, use everyday knowledge to help estimate the scale; e.g. given a model of a man, measure the height and use average male height to work out the scale factor</li> <li>given a scale factor, estimate the size of an original from a model or picture</li> <li>predict the effect on perimeter and area of doubling and tripling all the linear dimensions of a figure produced on a grid</li> <li>given a figure drawn on a grid, predict the effect on the area of doubling one dimension and tripling the other</li> </ul>

## Key Understandings

Teachers will need to plan learning experiences that include and develop the following Key Understandings (KU), which underpin achievement of the outcome. The learning experiences should connect to students' current knowledge and understandings rather than to their year level.

Key Understanding	Stage of Primary Schooling— Major Emphasis	KU Description	Sample Learning Activities
<b>KU1</b> For certain types of shapes we can describe the relationship between the lengths of its edges and its perimeter, its area and its volume.	Beginning ✓ Middle ✓✓✓ Later ✓✓✓	page 12	Beginning, page 14 Middle, page 16 Later, page 20
<b>KU2</b> When two things have the same shape: <ul style="list-style-type: none"> <li>• matching angles are equal</li> <li>• matching lengths are proportional</li> <li>• matching areas are related in a predictable way</li> <li>• matching volumes are related in a predictable way.</li> </ul>	Beginning ✓ Middle ✓✓ Later ✓✓	page 30	Beginning, page 32 Middle, page 34 Later, page 37
<b>KU3</b> Scale drawings and models have the same shape as the original object. This can be useful for comparing and calculating dimensions and for making judgments about position.	Beginning ✓ Middle ✓✓ Later ✓✓	page 44	Beginning, page 46 Middle, page 47 Later, page 49
<b>KU4</b> We can calculate one measurement from others using relationships between quantities.	Beginning ✓ Middle ✓✓ Later ✓✓✓	page 54	Beginning, page 56 Middle, page 57 Later, page 59
<b>Key</b> ✓✓✓ The development of this Key Understanding is a major focus of planned activities. ✓✓ The development of this Key Understanding is an important focus of planned activities. ✓ Some activities may be planned to introduce this Key Understanding, to consolidate it, or to extend its application. The idea may also arise incidentally in conversations and routines that occur in the classroom.			

## KEY UNDERSTANDING 1

*For certain types of shapes we can describe the relationship between the lengths of its edges and its perimeter, its area and its volume.*

The focus of this Key Understanding is students' *understanding* of commonly used measurement formulae. For certain types of 2D shapes (e.g. rectangle, triangle, circle) we know the relationships between specified lengths and the perimeter. We also know the relationship between specified lengths and the area. For certain types of 3D shapes (e.g. rectangular prism, cylinder) we know the relationships between specified lengths and the surface area and volume. Formulae are a shorthand way of describing these relationships. They are useful because they help us to work out perimeters, areas and volumes more easily than measuring them directly.

Memorising formulae is less important than understanding the relationships involved. Students need experiences over an extended period of time in order to understand these relationships. In particular, they will need to build up their understanding of the structure and use of rectangular arrays and how they link to multiplication (see Background Notes, Direct Measure, pages 164 to 166, and Background Notes, Indirect Measure, page 68).

Students should investigate measurement relationships in a range of ways, developing their own short cuts for solving practical problems and investigating patterns in tables and graphs. For example, they could make a graph that shows the circumference of circular lids of various diameters. The points should, theoretically, lie on a line, but are unlikely to fit exactly due to measurement 'error'. So long as the measurement is reasonably precise, however, the underlying relationship will still be evident and will enable students to predict the circumferences of other lids (and circles generally).

Students who have achieved Level 3 find perimeters directly or by measuring edges and adding. They can find the areas of shapes by placing tiles on the shapes and counting, but are also beginning to

predict how many tiles will cover a region by focusing upon the array structure of a rectangle and thinking about the numbers of rows.

Students who have achieved Level 4 will devise and explain their own shortcuts for finding the perimeter of polygons; for example, measuring one side of a regular pentagon and multiplying by five, or measuring two adjacent sides of a rectangle, adding and doubling. They understand that, although they could determine the area of a rectangle directly by covering it with unit squares and counting the number of squares and part squares, they could also work out the area of a rectangle composed of squares by thinking of it as an array and multiplying the number of squares high by the number of squares wide; that is, the number of rows by how many in each row. They also build prisms from layers of cubes and can generalise about the relationships between the number of cubes along the sides and the total of number of cubes in the shape.

Students who have achieved Level 5 understand and use the formula for the area of a rectangle even when the side lengths are not whole numbers (which means that the rectangle cannot readily be thought of as an array and the relationship is no longer intuitive). They have also learned to use this relationship to work out areas of other shapes. For example, they will break more complex shapes up into rectangles, for which they can find the areas separately. They also 'see' a triangle as half of a rectangle and can rearrange a parallelogram to form a rectangle of the same area. Each of these require that students understand that if you join two regions or split a region, the total area will be the sum of the parts. Students at this level can also use the formula for finding the volume of a prism from the length of its sides and break more complex shapes into prisms in order to find their volume.

## SAMPLE LEARNING ACTIVITIES

### Beginning ✓

#### Rectangular Boundaries

Have students make rectangular boundaries during imitative play and make up stories for the whole class. For example, *Queen Joanne built a fence around her square sand castle. She put ten posts along this side then she had to think about how many would be along the next side because each side looked about the same size. Or, Peter made a frame for his painting. He cut two pieces of tape the same size to put along the sides, and he cut two shorter pieces of tape for the ends.*

#### Displaying Work

Invite students to suggest regions on the walls that will be large enough to display their work. Ask: How could we find out if it is big enough? How many papers do you think will fit along the first row? How could we work out how many will fit altogether in that area? What other ways could we work it out? (Link to Estimate, Key Understanding 2.)

#### Modelling Clay Shapes

Ask students to use scone cutters and rolled out modelling clay to make multiple shapes the same size and shape as the end of a tin (triangular box, jelly packet). Have them stack the shapes to make a shape the same as the tin (triangular box, jelly packet). Ask: How many layers will you (did you) use to make the tin shape?

#### Stacking Blocks

Invite students to stack blocks in small rectangular prism-shaped structures such as haystacks and work out how many blocks they used. Ask: How many layers (slices) are there? Help students separate the blocks to show how many layers (slices). Ask: How many rows of blocks are in each layer (slice)? How many blocks tall (wide) is each layer (slice)? Help students to use their calculator to add on each slice or layer. (Link to **First Steps in Mathematics: Number**, Understand Operations, Key Understanding 3).

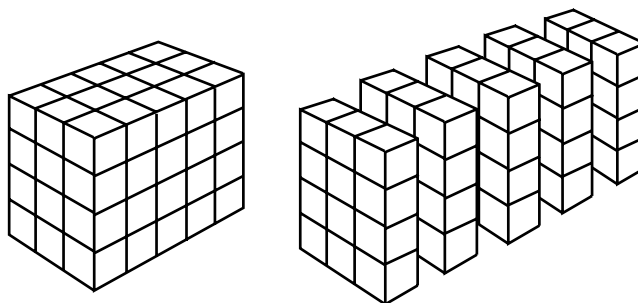

### Same Number of Tiles

Have students make many different rectangle shapes with a given number of square tiles. Ask them to trace around their tiles to record each rectangle on paper and use the dimensions to describe their rectangles. For example, *I made this one by doing 6 rows of 2 tiles and this one with 3 rows of 4 tiles. I used 12 tiles each time.* Have students then measure the perimeter of their rectangles with string and compare the lengths. Ask: How many tile edges fit along the length of string? How is it that the two pieces of string are different lengths when you used the same number of tiles to make both rectangles? Why do you think that happens? Will it be different again if you make another 12-tile shape? Draw out the idea that even though there is the same number of tiles there are different distances around. (Link to **First Steps in Mathematics: Number**, Understand Operations, Key Understanding 3.)

### Covering a Rectangle

Invite students to work out the number of tiles taken to cover a rectangle. For example, give them multiple copies of a tile or square that exactly matches the markings around the rectangle. Invite them to try to arrange the tiles so they exactly cover the rectangle. Ask: How many squares does it take? How do the tiles fit with the marks around the edge of the rectangle? (See Middle Sample Learning Activity 'Covering a Rectangle' and Did You Know?, page 29.)

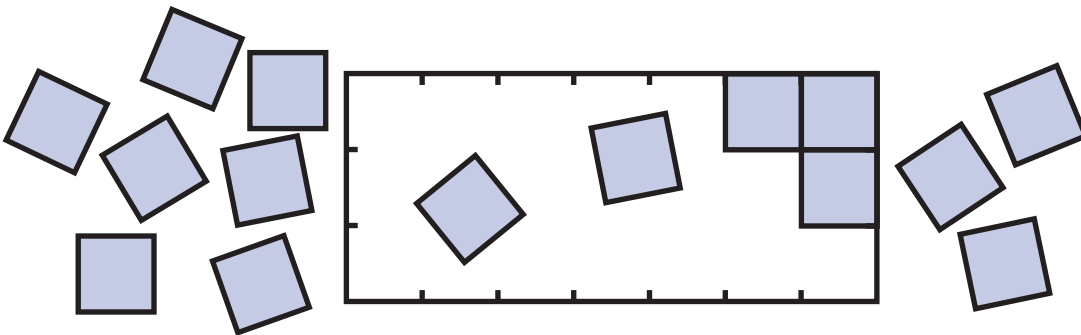

## SAMPLE LEARNING ACTIVITIES

### Middle ✓✓✓

#### Shortcuts for Perimeters

Have students directly measure the perimeter of various rectangles, then look for shortcuts and write down instructions that others can follow. Invite them to share their methods and say how each is related to the sides of the rectangle. For example, *We measured the long side and the short side together and doubled the number.* Or, *We did it differently. We measured the long side, made it times two, and then added it to the short side times two.* Ask: Would your method work for all rectangles? Will it work for squares? Why? Why not?

#### Fencing for a Paddock

Have students work out the perimeter of rectangles when part of the border is hidden. For example, say: The farmer wants to work out how much fencing to buy for his rectangular paddock but can only measure part of what he needs. Ask: Can you help him work out how much fencing he needs?

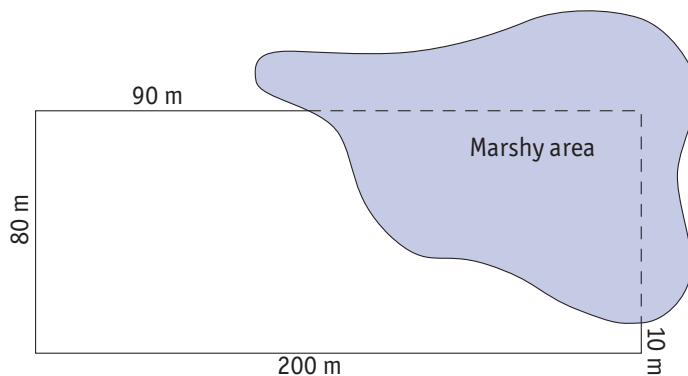

#### Covering a Rectangle

Extend Beginning Sample Learning Activity 'Covering a Rectangle' by asking students to first predict how many tiles they think will cover the rectangle. Invite students to use a cardboard square as a template and draw around it to check their prediction. Ask: How many squares cover the rectangle? How did you count them? How would counting how many squares in one row be helpful? How could your ruler help you with this? (rule lines to join the marks) (See Background Notes, page 68.)

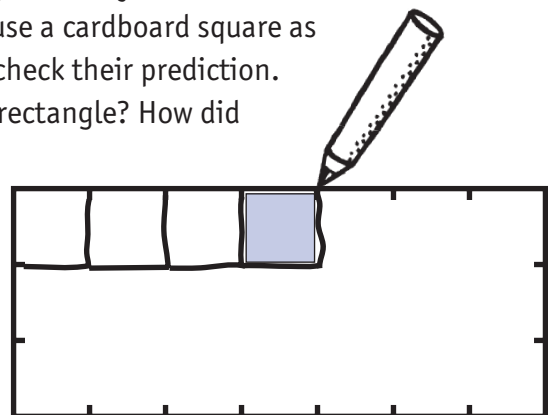

**Incomplete Grids**

Have students use incomplete grids to find the number of squares in a rectangle. For example, show students the diagram below and say: Fumiko made a table. She is covering it with decimetre square tiles. She has bought 54 tiles. Is this going to be enough to cover the table? How do you know? Does knowing that there is 12 in a row help you? How? Does knowing that there is 6 in a column help you to work it out? How? (Link to Understand Units, Key Understanding 7.)

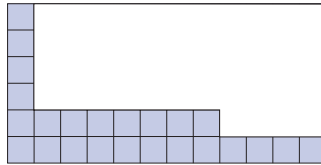
**Picnic Blankets**

Have students use incomplete grids to find the number of squares in a rectangle. For example, say: Some students were working out how many squares there were on the picnic blanket. Could they work it out without taking the trays and plates off? How? How many squares in a row? How many squares in a column? How does knowing this help you work it out? Encourage students to share their counting, skip counting, adding or multiplying strategies and decide which one is the quickest and easiest.

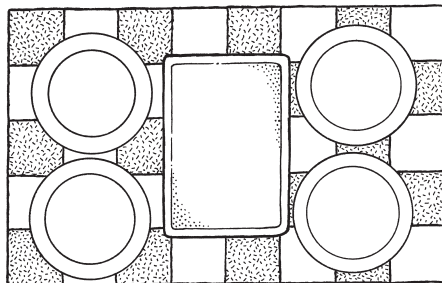
**Twenty-Four Tiles**

Have students construct as many different rectangles as possible with 24 tiles, using all the tiles each time. Ask them to record each one on grid paper and in a table, for example:

Side 1	Side 2
3	8
2	12
24	1

Have them order the rectangles so that the length of side 1 increases as they read down. Ask: What do you notice about the pairs of numbers? (they multiply to give 24) Why does this happen? (the number in side 1 tells you how many tiles in one row and the number in side 2 tells you how many rows) How can we check we have made all the possible rectangles?



## Middle ✓✓✓

### Oil Spills

Give pairs of students an A3 copy of a map showing two different oil spills. Ask them to use squares of paper ( $2\text{ cm}^2$ ) to compare the areas of the oil spills. Ask: How can we place the squares so that there are no gaps between them? Can you use rows of squares? Can you arrange the rows into rectangles that fit inside the shapes? How could you make the counting of the squares easier? Help the students to move from counting all the squares to counting how many in each row and adding the rows. (See Direct Measure, Key Understanding 2.)

### Pizza Trays

Have students carefully arrange square units in a range of shapes to find the area. For example, ask students to measure the area of circular and rectangular pizza trays to find out which is larger. Ask: Why is it easier to count the squares inside the rectangular shape? Can the squares in the circular shape also be placed into rows? How would that help you work out how many squares in the circle? What can you do about the gaps left around the edge? (See Direct Measure, Key Understanding 5.)

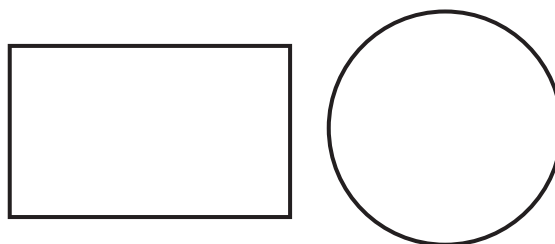

### Which Paddock Is Bigger?

Have students use 2-centimetre paper or cardboard square tiles to explore ways to work out which of the paddocks shown is bigger. Ask: Which is easier to measure? Why? Can you find a way to use the tiles for the triangle? How would arranging rows of tiles in an array help? Would it be useful to imagine doubling the size of the triangle to make a rectangle? How?

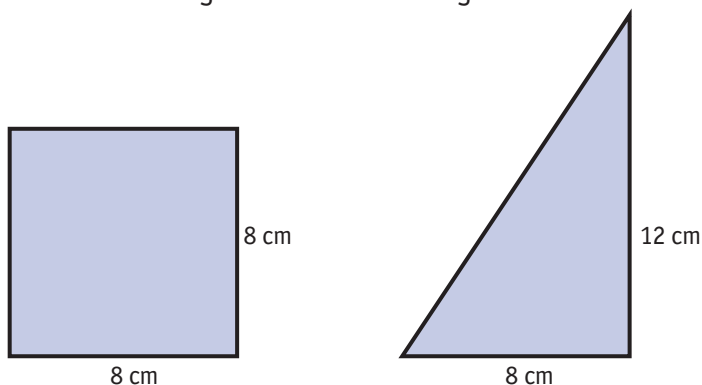

**Buildings**

Ask students to construct solid 'buildings' with cubes, telling them that only full faces of cubes can touch each other. Have their partners work out how many cubes have been used. Ask: Can we use addition rather than counting each block separately? What could be added together? Can you see larger box shapes within the building? How can you use your calculator to help work out how many blocks are needed? Could multiplying help?

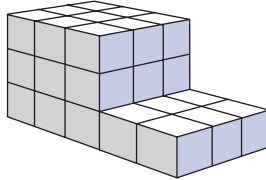
**The Sealed Room**

Have students use cubes to build rectangular prisms in order to work out the volume of the prisms. For example, say: People are locked in a sealed room 4 metres long, 2 metres wide and 3 metres high. We need to know how much oxygen there is, so we need to work out the volume of the room in cubic metres. Ask students to build the room with 1- or 2-centimetre cubes, pretending each is a metre cube. Ask: What is the volume of the prism? Then, say: What if they were locked in a sealed room 3 metres long, by 3 wide and 2 metres high? What would the volume be? Have them record their results in a table.

Length	Width	Height	Volume
4 m	2 m	3 m	24 cubic m
3 m	3 m	2 m	18 cubic m

Invite students to explore other rooms with different dimensions and add the information to the table. Ask: Can you see any patterns? Can you use your calculator to find short cuts for working out the number of cubic metres? Could you work out the volume for another room without using the cubes?

**Twenty-Four Cubes**

Ask students to build rectangular prisms from 24 cubes each and record the dimensions in a table: how many cubes in a row, how many rows in one layer, and how many layers. Ask: How do you know you have made every possible rectangular prism? How could you work out the number of cubes in any rectangular prism from its measurements? (Link to **First Steps in Mathematics: Number**, Reason about Number Patterns, Key Understanding 6, and Reason Geometrically, Key Understanding 4.)

## SAMPLE LEARNING ACTIVITIES

### Later ✓✓✓

#### Three Rectangles

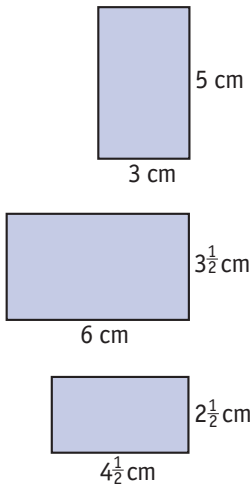

Give students a series of rectangles drawn to full size, but without the measurements shown. Include whole number and fraction examples. Ask them to work out the perimeter of each one. Ask: How did you work out the perimeters? (They might use centimetre grid paper, draw in grids of their own, or measure and calculate.) Do all the ways of working it out give the same result? Should they? Why? Why not? Which ways were the easiest? Which were the most accurate?

#### Turf and Rope

Extend 'Three Rectangles' by saying: A gardener wants you to work out the perimeter and area of rectangular lawns for her because she needs to know how many square metres of turf to buy and how much rope she will need to enclose the lawns while the turf grows. Challenge students to find the easiest way to do this. Ask: Can you find rules that will work for every rectangular plot? What would you write down so that someone else would understand your rules? Are your rules the same or different from others? How?

#### Irregular Areas

Have students look for arrays within irregular shapes to help work out the area. For example, say: The farmer needs to find out the area of her paddock (pond) to know how much seed (mosquito spray) to buy. Ask: How could she work out the area? Could rectangles that fit inside the shape help with this? How? Invite students to draw the shape onto the grid paper to help them see the arrays within. Later, ask: Could you work it out without using grid paper? (See Direct Measure, Key Understanding 5.)

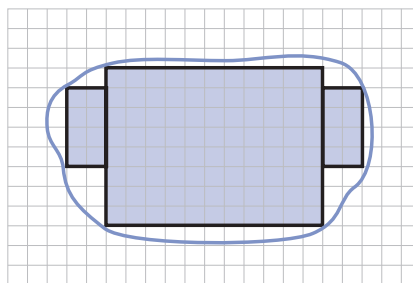

Could you just draw rectangles inside and work it out without using grid paper?

Would your ruler help?

How will you measure the gaps around the edge?

#### Square Straws

Ask pairs of students to make different-sized rectangles from straws (popsticks, matchsticks). Invite them to describe the area of their rectangles. For example, *My rectangle is 2 straws by 4 straws and has an*

area of 8 square straws. Draw out how the different linear unit they chose needs to be 'squared'. Invite students to give their partners area measures (e.g. 10 square matchsticks) and have their partner make as many rectangles as they can with that area. Ask: Why do you need to know the unit before you can make the rectangle?

### Which Unit

Extend 'Square Straws' by having students calculate the areas and perimeters of rectangles where the dimensions are given in standard length units. Ask them to write their answers down and explain why they needed to include units with the numbers, and how they chose which units to use. For example, ask: Is the area of a 4 centimetre by 3 centimetre rectangle 12, 12 squares, 12 centimetres, 12 square centimetres or 12  $\text{cm}^2$ ? What if the dimensions include fractions? How does that affect the area?

### Perimeter or Area?

Have students decide whether perimeter or area measure has been used. For example, say: This piece of homework was found on the floor. Ask: What might the questions have been? How can you tell? What did you do to check? Why can't you say for sure whether question 2 is 'What is the perimeter?' or 'What is the area?'. How would seeing the units tell us for sure? (cm or  $\text{cm}^2$ ) Are there any other rectangles where the perimeter and the area both have the same number of units?

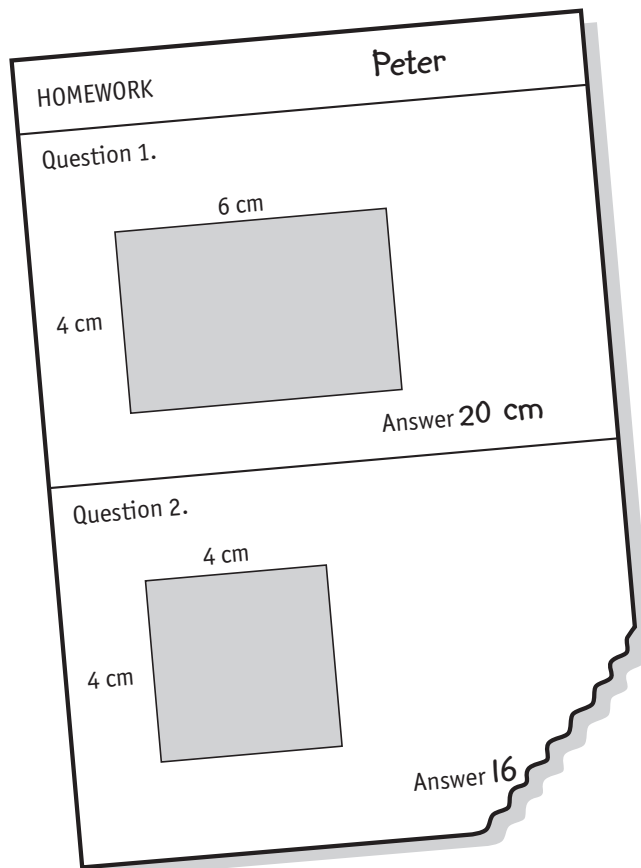

## Later ✓✓✓

### House Plans

Have students use house plans drawn to a simple 1 centimetre to 1 metre scale to work out the floor area of different-shaped rooms for a purpose (e.g. how much carpet or how many floor tiles would be needed to cover it). Ask: What can you do to work out the area of the rooms? How would thinking of the rooms as separate rectangles be helpful? What tools could you use to help? (grid paper, ruler, scissors) How would you use the tools? Once students have worked out the area, stimulate a class discussion by asking: Which ways were quicker and easier? Why? (Link to Key Understanding 4, and **First Steps in Mathematics: Number**, Understand Operations, Key Understanding 3.)

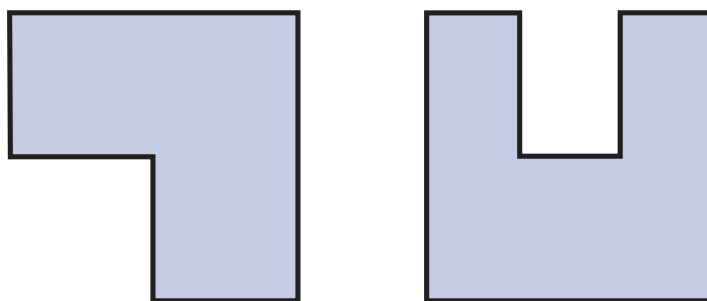

### Lunch Boxes

Have students use cubes to solve volume and capacity problems, looking for shortcuts to arrive at the total number of cubes used. For example, say: A school group were on an excursion when they broke down and had to trek a distance and carry water back in their lunch boxes to fill the water container that held one cubic metre. Would they be able to carry back enough water to fill it in one trip? Invite students to use cubes to work out the capacity of their lunch boxes and encourage them to look for shortcuts. Ask: How do the rows and layers of cubes help you think about how many cubes fit or match? How could you use your calculator to make it easier to count how many? How can you work out the volume if you don't have enough cubes to fill all the box? (See Sample Lesson 1, page 26; link to Key Understanding 4 and **First Steps in Mathematics: Number**, Understand Operations, Key Understanding 3.)

### The Sealed Room

Extend Middle Sample Learning Activity 'The Sealed Room' by having students build some larger rooms. Make sure there are not enough cubes to build the rooms completely. Ask: Can you work out how many cubes you would need if you completely built the room? Would counting rows and layers help? How? Invite students to work out a general rule that would work for any room. Ask: How can you be sure it will always work?

### Cubic Straws

Extend later Sample Learning Activity 'Square Straws' by asking pairs of students to build rectangular prisms from straws (popsticks, matchsticks) using modelling clay or joiners for the corners. Help them describe the volume of their prisms in terms of the linear unit used (e.g. cubic straws, cubic popsticks, cubic matchsticks). For example, *My prism is 2 straws high, 2 straws across and 3 straws long and its volume is 12 cubic straws.* Ask: How is a 1-straw cube (1-popstick cube, 1-matchstick cube) related to your prism? What do you mean when you say the volume is 12 cubic straws (popsticks, matchsticks)? (*If I had 12 wooden cubes, each one straw wide, I could build a prism exactly the same size and shape as my straw skeleton.*) Why do we say 'cubic straws', rather than just 'straws' when giving the volume? Could you make a prism that is not a cube, but has a volume of 1 cubic straw? What if you could cut some of your straws in half? What might the dimensions of the prism be? Later, have students use standard length units to describe the dimensions of rectangular prisms and to calculate and record volume.

### Fractional Dimension

Extend 'Lunch Boxes' and 'The Sealed Room' to include some prisms with one fractional dimension. For example, say: A room is 3 metres long, 4 metres wide and 2.5 metres high. How can we work out the capacity of the room? What would a half layer be like? Can your general rule still be used?

### Triangle in a Rectangle

Have students draw a rectangle around a triangle. Invite them to compare the area inside the triangle to the area outside. Ask: What do you notice? Try other triangles that can be enclosed by the same-sized rectangle. Ask: Is the area outside the triangle the same as the area inside the triangle for others as well? What is the area of the rectangle? How could you use the area of the rectangle to easily work out the area of the triangles? Can you write down a general rule that others could use to work out the area of a triangle from the area of the rectangle it will fit inside? Have students use the general rules of other students to see if they work. Ask: Can you explain why the general rules work?

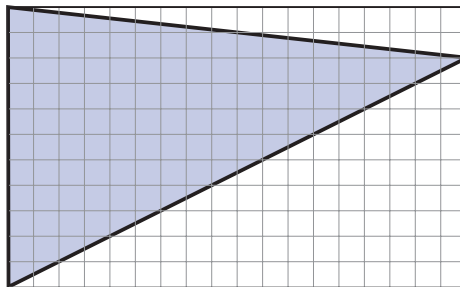
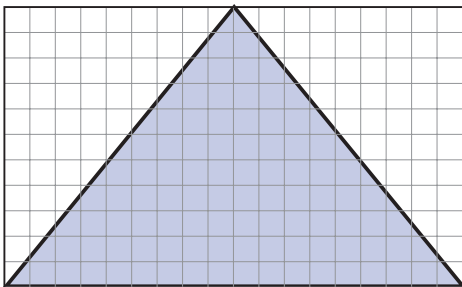

## Later ✓✓✓

### Five Triangles

Have students investigate the areas of different triangles with the same height and base. For example, say: Jeremy has a new rule that says, *All triangles drawn on the same base and with the same height have the same area.* Ask: Does it work? Always? Must it? Can you find a reason why? How does it help you work out the area of triangles? Invite students to cut and rearrange the parts of each triangle so that it fits into a rectangle that has the same width as the triangle's base. Ask: Are all the rectangles the same height? Compare this to the height of the original triangles (should be half the height). How could you use what you know about the area of rectangles to work out the area of triangles?

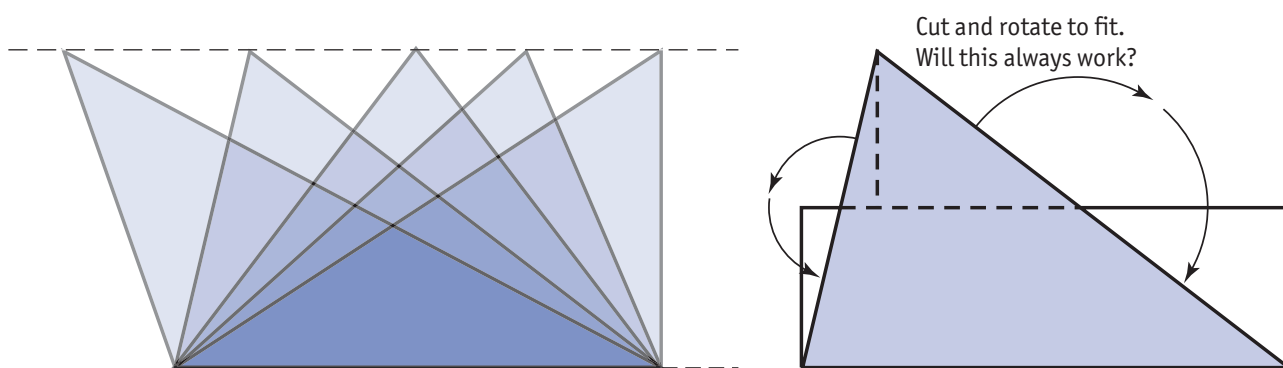

### Rearranging Parallelograms

Have students cut and rearrange parallelograms to make rectangles. Invite them to investigate relationships between length measures on the parallelograms and on the related rectangles. Ask: Can you work out a formula (set of rules) that others can use to calculate the area of any parallelogram? Encourage students to use what they know about finding the area of a rectangle.

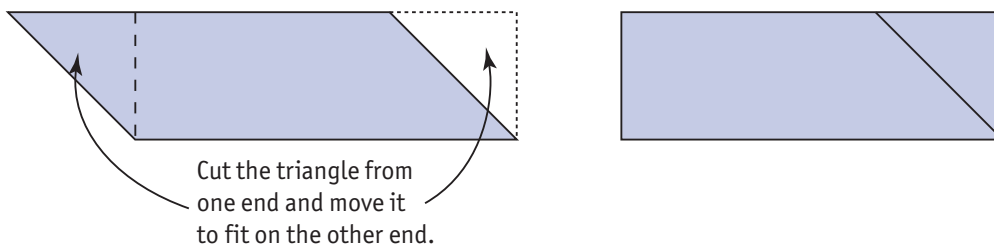

### Circles

Ask students to find the diameter and circumference of circular objects (e.g. lids, plates, wheels) with string or thin tape. Have them display their results by lying diameter lengths beside the circumference length for each object.

Ask: What do you notice about the number of diameters in each case? (the circumference is just over three diameters)

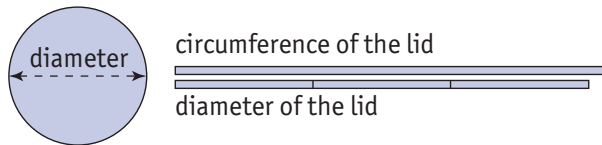
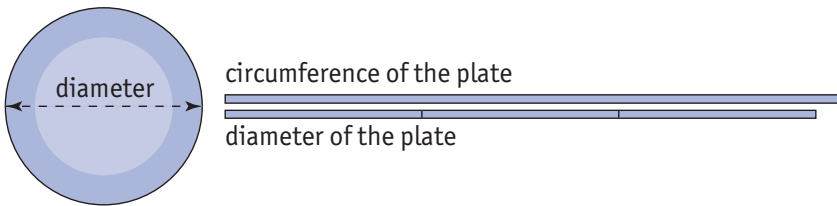

Have students measure their strips and record the diameter and circumference for each object. Combine the information and draw a class graph of all the results with diameter on the horizontal axis and circumference on the vertical axis. Ask: Can you see a pattern in the points? (Ideally they would be exactly on a line, but in practice students' measurements will often vary a little.) Draw out that the points are 'pretty close' to being on a line. Draw the line. Invite students to measure the diameter of a different circle. Use the graph to estimate its circumference. Ask: How could you check this on the circle? How could you use your calculator to check the result?

The jar measured 8.5 cm across the top so the circumference should be about 27 cm

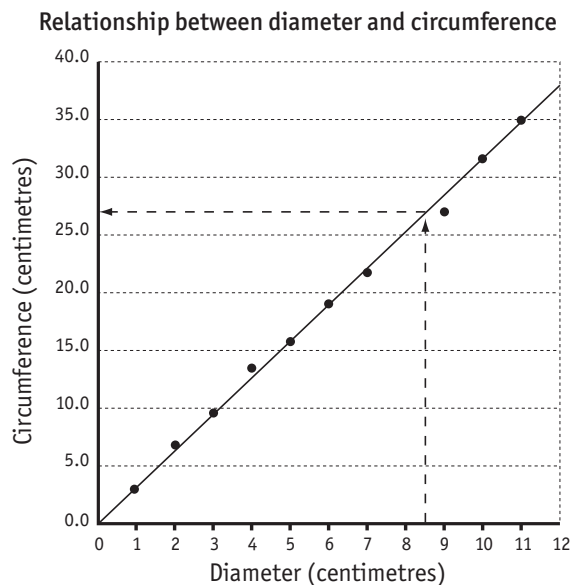

**Fringing**

Extend 'Circles' by asking students to use the relationship that the circumference is three and a bit times the diameter to estimate quantities. For example, say: The diameter of a circular lampshade (cushion) is 35 centimetres. How much fringing (braiding) will I need to go around its edge? (Link to Key Understanding 4, and **First Steps in Mathematics: Number, Understand Operations, Key Understanding 3.**)



## SAMPLE LESSON 1

**Sample Learning Activity:** Later—‘Lunch Boxes’, page 22

**Key Understanding 1:** For certain types of shapes we can describe the relationship between the lengths of its edges and its perimeter, its area and its volume.

**Working Towards:** Level 4

### Teacher’s Purpose

My Year 7 class associated the word ‘volume’ with ‘length by breadth by width’, but they didn’t seem to understand what it meant. I wanted to draw out the mathematical relationship underpinning the formula.

### Motivation and Purpose

I told the students a rather fanciful story about a school group going on a trip and breaking down and needing to trek a distance and carry water back in their lunch boxes to fill the water container that held one cubic metre. Would they be able to carry back enough water to fill it in one trip?

After some discussion, the students decided they’d each need to work out the capacity of their own lunch box and then add them all. We had plenty of dry materials in the classroom, but I made up an excuse why they couldn’t get water.

### Action and Reflection

The students worked in pairs with their empty lunch boxes. Most chose something to represent a unit and counted how many or how much fitted in their box. A few used rulers to take measurements of the height, width and length of their boxes. We talked about what they had done and I drew out that they had found the capacity of their boxes and the capacity was actually the inside volume of the box.

‘That’s great,’ I said, ‘so you all know the volume inside your lunch box.’ They nodded.

‘So how does that help with our problem?’

In the flurry of activity, most had lost sight of the original problem, but now remembered, ‘We have to add the inside volumes.’

Dougal then asked, ‘But how can we add them up if everyone used different measuring stuff? We should all use the same thing.’

*This is the basis of the need for standard units.*

Everyone agreed that this was a good idea. There was then some heated discussion about what to use, with some favouring 'flowing' materials such as rice because they were easy to use and others favouring cubes because they stacked. Finally, to my relief, the 'cube' brigade won, using the argument that even if we worked out how many scoops of rice there were altogether, we wouldn't know how many scoops was equal to a cubic metre.

### Connection and Challenge

But still we had a problem. There wasn't enough of any one material for everyone to use! The challenge was to come up with a way to find the volume inside their lunch boxes without having enough cubes to fill it.

Most used up all their blocks and then looked for ways of calculating how many more would fit.

I noticed that quite a number of pairs had carefully counted the number in the bottom. I stopped the class and asked Dougal and Bala to explain what they were doing. Dougal said that they had 220 on the bottom and thought that each layer of cubes would be the same so they just needed to work out how many layers. I asked the students how many others were trying that approach and a number were.

'How will you work out how many layers?' I asked.

'By seeing how many go up the side,' several suggested.

'So, Bala, how many go up the side of yours?'

'Five,' she said. I noticed that she actually needed six layers and had not counted the bottom layer in her five going up the side.

'So, what will you do with the five?'

Bala said they would add on five more lots of 220.

I asked the students to help Bala and work out the volume for her. We all agreed that 1320 cubes would fit in her lunch box.

'Is there a shortcut for that?' I asked.

'You could multiply,' several replied.

I asked them to do it and, of course, some multiplied by five while others multiplied by six, so that when I asked what the answer was, there were two different responses. I left it to one of the confident students to explain why you needed to multiply by six.

'There are six lots altogether,' he said, 'six lots of 220.'

*I had previously decided that, if the majority favoured a 'flowing' material such as rice, we would use that. There would not have been enough material and so students would have run into trouble when they tried to measure all the lunch boxes. I thought I might use that to 'woo' them over to using cubes. If, however, they came up with a good strategy using their chosen material, I would have returned to cubes in a follow-up lesson. That the students decided to use 1-centimetre cubes simply meant we reached the point I wanted more quickly.*

‘So, what does the 220 tell you, Bala?’ I asked.

‘How many in the bottom,’ she said.

‘And what does the six tell you?’

‘How many lots of 220,’ she replied.

### Drawing Out the Mathematical Idea

I rephrased Bala’s responses, ‘Bala has said that the 220 is how much in a layer and the six is the number of layers.’ I then asked, ‘So, if we want to find the inside volume of our boxes, what do we need to do?’

Jodie replied, ‘Find out how many cubes it takes to cover the bottom and then how many layers of cubes you would need to fill it and then multiply them.’

I wrote this on the board to give it emphasis and beside it I wrote:

$$V = \text{number in one layer} \times \text{number of layers}$$

Students who had filled more than one layer began moving blocks into a stack up the side. I had noticed earlier that Hanadi and Justin had placed cubes inside their lunch box along two adjoining edges then made a stack in a corner. After most students had worked out the volume of their two boxes using the layers, I asked Hanadi to explain their approach.

‘We only had to multiply the rows together, then multiply the answer with the height.’

‘Would this work for all of the lunch boxes?’ I asked. ‘Test it on your boxes.’

Students reached for their calculator to do the multiplication.

‘Yes, it does,’ agreed most.

‘So, why does it work for all of the different boxes?’

‘Well,’ said Hanadi, ‘you are really finding out how many in the bottom layer and then how many layers you have.’

Others agreed. ‘Yes, you just times how many in one layer by the number up the side.’

‘What does this have to do with how many in a layer?’ I asked.

Dougal offered, ‘You’re just timesing the sides.’

There were a number of nods of agreement—we had previously found areas of rectangles based on square grids.

I wrote on the blackboard:

$$V = \underline{\text{side 1}} \times \underline{\text{side 2}} \times \text{number of layers}$$

and asked them to tell me again what the underlined bit showed.

'Hey,' said Ariel, 'that is like volume is equal to length times breadth times height that we did last year.'

'Yes,' I said, 'it is the same. Side 1 could be the length and side 2 could be the breadth. The volume of a rectangular box can always be worked out by multiplying the length of the two sides by the height of the box.'

The students then used this to work out the inner volumes of their lunch boxes, which were recorded on the board and then added by the students. At this point, several realised that they had worked out the volume in cubic centimetres and had to decide whether they had more or less than a cubic metre. The lesson continued ...



### Did You Know?

Show students a rectangle marked as shown and a square cut out that exactly matches the markings so that, for this example, seven squares fit across the rectangle and three down. Ask them to predict how many squares they need to cover the rectangle. Do not initially give students a square to place or draw around, although later they should check their prediction.

We often assume that students can 'see' the arrays in rectangular arrangements, but a surprising number have difficulty with tasks such as this.

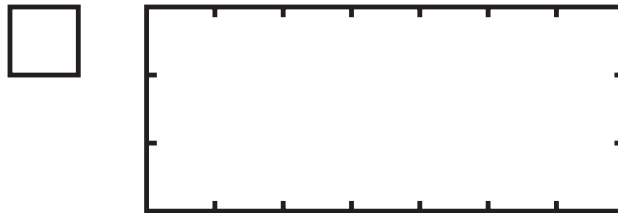

## KEY UNDERSTANDING 2

*When two things have the same shape:*

- *matching angles are equal*
- *matching lengths are proportional*
- *matching areas are related in a predictable way*
- *matching volumes are related in a predictable way.*

The focus of this Key Understanding is the development of students' understanding of what we mean mathematically when we say that two figures or two objects are 'the same shape' and of some of the basic mathematical relationships involved (see Background Notes, page 68). This links closely to Key Understanding 3 and Key Understanding 4 in Space: Represent Transformation.

When we use a photocopier to enlarge or reduce something, the essential idea is that the copy should 'look the same' as the original. Thus, the shape of the copy must be the same as the shape of the original. This is achieved by ensuring that angles on the copy are the same as matching angles on the original, and that lengths on the copy are a fixed multiplier of matching lengths on the original. This fixed multiplier is called by different names in different contexts: the scale factor, scale ratio, enlargement factor, magnification. If we want to double the dimensions of the original, we use a scale factor (multiplier) of  $\times 2$  (or 200%). Every length of the original is then doubled, while the angles are kept the same. If we want to halve the dimensions of the original, we 'enter'  $\times 0.5$  or 50% of the original, thus telling the photocopier to halve all lengths. If we want it to be one-and-a-quarter times as big, we enter 1.25 or 125%. If the scale factor is bigger than 1, the copy (or scaled version) will be bigger; if the scale factor is less than 1, the scaled version will be smaller.

When we produce a copy, we are sometimes surprised at the 'size' of what we produce. For example, when we make a half-sized copy of the word *dog*, using a 50% scale, the copy we produce may seem

much smaller than half. This is because the area of the copy will have quartered and so 'look' much less than half size.

The effect can be even more surprising for a 3D object. When we halve its dimensions, all areas are quartered, but the volume is reduced to one eighth.

Activities should be provided that help students to develop an understanding that when we enlarge or reduce figures and objects we change the size without changing the shape. This means that the angles do not change, but all the lengths change by the same multiple (called the scale factor). Older primary students should begin to investigate the effect of scale changes (e.g. tripling all the length dimensions) on the perimeter, the area and the volume of shapes. This will lead, during the early secondary years, to the generalisation that, if two objects have the same shape:

- each angle on the first will be equal to the matching angle on the second
- each length on the first will be a fixed multiple (say, times  $k$ ) of the matching length on the second
- each area on the first will be  $k^2$  times the matching area on the second
- each volume on the first will be  $k^3$  times the matching volume on the second.

Students who have achieved Level 3 will show a general sense of scale when selecting things for a purpose. They may adjust items for a model they are building, using language such as *It needs to be smaller to look right*.

Students at Level 4 use grids to enlarge and reduce in specified ways and to produce systematic distortions. They understand that for a copy to 'look the same' as an original all lengths must be multiplied or divided by the same amount (for example, all halved or all tripled) and angles must remain the same. They predict the length of lines on the copy from the length of lines on the original.

At Level 5, students also use grids and arrangements of cubes to investigate and draw conclusions about the effect of scaling linear dimensions on the perimeter, area and volume of figures and objects. They will work out that if an arrangement of four cubes is scaled up by a factor of three (that is, made three times as big in each direction), then 27 times as many cubes will be needed; that is, 108 cubes.

dog  
dog

KU2

## SAMPLE LEARNING ACTIVITIES

## Beginning ✓

## Enlarging

Have students use small square tiles to create a shape or design. Then, have them copy the shape or design, making it twice the size, by encouraging them to first look at one tile and make another shape that is two tiles wide. Ask: How many tiles will you need to get it to be a square? Why aren't two tiles enough? (to make it square you have to double the height as well) Encourage students to look at enlarging their design by making every unit square into a bigger square that is two squares wide and two squares high. (Link to *First Steps in Mathematics: Number*, Operate, Key Understanding 3, and *First Steps in Mathematics: Space*, Represent Transformation, Key Understanding 3.)

## Mothers and Babies

Show students mother and baby animal pictures and have them describe the differences between them. Ask: Is the baby an exact copy of the mother? Which parts of the baby's body will change the most? Which baby animals are exactly the same shape as their parents? (See *First Steps in Mathematics: Space*, Represent Transformation, Key Understanding 3.)

## Jumpers and Chairs

Have students compare objects that vary in size (e.g. a baby's jumper, a child's jumper and an adult's jumper; a Year 1 chair, a Year 4 chair and a Year 7 chair). For example, ask: How are the jumpers the same? How can you tell they are all jumpers? (the shape is the same) How are the jumpers different? (in size). (See *First Steps in Mathematics: Space*, Represent Transformation, Key Understanding 3.)

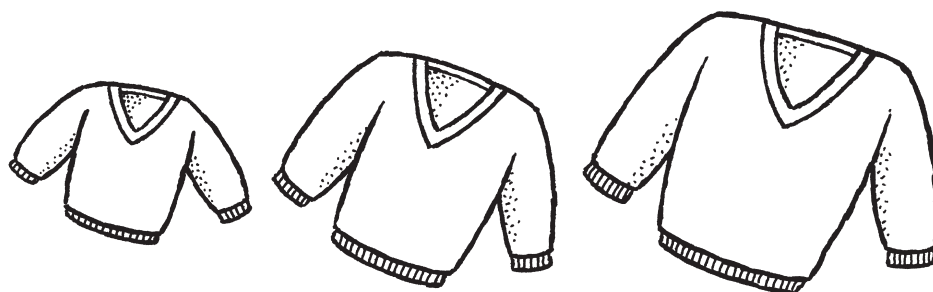

**Graduated Sets**

Have students use graduated sets of objects for imitative free play (e.g. sets of mixing bowls, sets of saucepans, plates, measuring cups, measuring spoons, nesting cups, baskets). Mix them together and ask students to sort them into sets to pack away. Focus the discussion on 'exactly the same shape but different sizes'. Ask: How do you know all the bowls go together? This saucepan is the same size as this bowl, why not put it with the bowls? What is the same about all the bowls? (Link to **First Steps in Mathematics: Space**, Represent Shape, Key Understanding 1, and Represent Transformation, Key Understanding 3.)

**Popstick Squares**

Have students make a square using four popsticks. Ask them to make a large copy of the square using two or three popsticks for each side. Display the range of sizes. Ask: Are the shapes the same (different)? How? What did James do to the first square to make this square? Did he do that to only one side? Why? Extend this to other rectangles to draw out the idea that to keep the shape every side must be changed in the same way (e.g. if one side is doubled, all sides must be doubled). (Link to **First Steps in Mathematics: Space**, Represent Transformation, Key Understanding 3.)

**Photocopy Enlargements**

Cut A4 sheets of paper into quarters and have groups of students draw some pictures on the quarter sheets. Use the photocopier to enlarge each twice, once to A5 and then enlarge the A5 copy to A4. Return the original and the two enlargements to the students and ask them to compare the pictures in their groups. Ask: What has changed? What has stayed the same?



## SAMPLE LEARNING ACTIVITIES

## Middle ✓✓

## Triangles and Other Shapes

Have students use pattern blocks to explore the effect of enlarging by doubling and tripling dimensions. For example, use the triangles to make a larger triangle with each side twice as long as a single triangle. Ask: How many triangles did you need to make the triangle twice the size? Was it twice as many? Why not? Ask students to make a shape that is three times the size of the single triangle. Ask: What part is three times bigger? How many triangles did you need to make a triangle that was three times the size? Was it three times as many? Why not? How many 'times as many' was it? Invite them to work out how the length and area measures change when they double and triple the size of the blue rhombus and the square. (Link to Understand Units, Key Understanding 3.)

## Enlarging a Design

Have students use straight lines to draw a design onto a four-by-five grid that has 1-centimetre squares. Then have them make a copy on another four-by-five grid that has 2-centimetre squares. Invite students to compare the lengths (including diagonals), areas and angles. Ask: What has changed? What has stayed the same? How have the lengths changed? How has the area changed? Later, include designs with curved lines. Ask: How has the length of the curved lines changed? How has the area changed?

## Reducing a Design

After activities like 'Enlarging a Design', ask students to say what changes when the straight-line and curved-line designs are reduced. Ask: If the length of the straight lines are half as long, what do you think will happen to the length of the curved lines? How has the area changed?

## Comparing Enlargements and Reductions

Have students compare their enlargements and reductions from 'Enlarging a Design' and 'Reducing a Design'. Ask: Are the changes to each measurement the same (different)? How? Draw out that by doubling the lengths, the area is always multiplied by four. If the lengths are halved, the area is quartered.

### Figures on a Grid

Give students figures on a grid that are enlargements or distortions of each other. Have them circle the enlargement that is 'the same shape but bigger (smaller)'. Discuss reasons for their choices. For example, *That one is not the same shape, that one has been stretched and that one has been squashed.* Use a variety of simple, everyday shapes and ask students to decide which ones are the same shape but bigger (smaller).

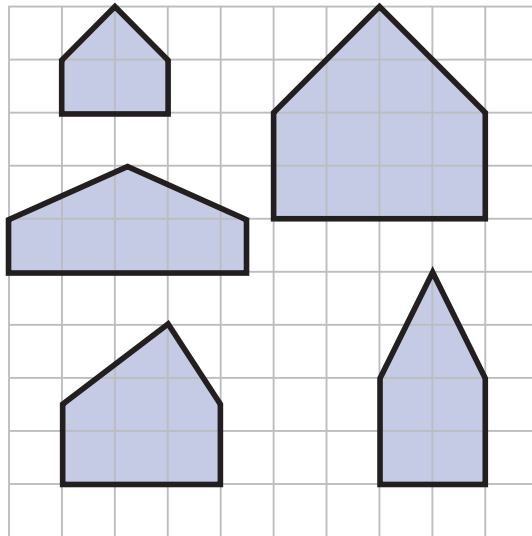

### Graphics

Invite students to use a graphics program to create images. Ask them to predict how the image will change when it is dragged from a corner or from the horizontal or vertical edge. Ask: What measurements are changing when it is dragged from the top (side, corner)? Is it an enlargement (reduction) or a distortion? (See *First Steps in Mathematics: Space*, Represent Transformation, Key Understanding 3.)

### Making Cubes

Invite students to create a cube using plastic interlocking squares or squares of card taped together. Then, have them create another cube that is twice the size. Ask: What does 'twice the size' mean? Draw out the ambiguity. Ask: Is it a cube with sides twice as long? Is it a cube that takes up twice as much space? Say: Suppose we mean we want a cube with sides twice as long. How many pieces were needed for the original cube? How many will be needed for the bigger cube? Why did we need four times as many instead of just twice as many?

## Middle ✓✓

### Wooden Cubes

Repeat 'Making Cubes' using wooden cubes. Invite students to put out one cube and then make another cube that is twice the size of the first. Invite students to predict how many cubes they will need, then text their prediction. Ask: Why weren't four cubes enough? Why did you need eight times as many wooden cubes?

### Chair Factory

Have students say how doubling the linear dimension changes the volume. For example, say: A factory manager had an order for a chair twice as big as this classroom chair. What measurements would you have to make? Ask students to make a 3D model of a chair using no more than about five cubes. Then have them double all the linear dimensions. Ask: How has the volume changed? Is the amount of change the same for different model chairs?

## SAMPLE LEARNING ACTIVITIES

### Later ✓✓

#### Enlarging a Picture

Photocopy a cartoon drawing onto square grid paper and have students enlarge it using a grid. Ask: If you double the length of each side, what happens to the area? What happens to the area when you triple the length of the sides? Can you predict what the area would be if you enlarged the dimensions four times? What changes (stays the same) in the enlargements? What is it about the shape that stays the same in each enlargement? Draw out that the lengths and areas change in a predictable way, but the size of the angles always stay the same.

#### Reducing a Picture

Extend 'Enlarging a Picture' by giving students a different, large picture on grid paper and asking them to reduce it. Ask: When you halve the length of each side, what happens to the area? What do you think will happen to the area if you reduce the dimensions to one third of their original size? What about the angles? Encourage students to test their predictions.

#### Changing Shape

Have students say what happens to the angles, lengths and areas of shapes when the two linear dimensions are changed by different amounts. For example, invite students to draw a straight-line sketch of a fish on grid paper. Then, ask them to make the fish twice as long and twice as high. Invite them to measure the lengths on the two fish. Ask: How do matching lengths compare? Then, ask them to work out the area of the body of each fish. Ask: How do they compare? Have them measure the angles. Ask: How do they compare? Have students make another fish the same height as the original, but twice as long. Ask: How is the last fish the same as (different to) the original fish? Invite students to compare the matching lengths on the fish. Ask: How do they compare? What happens to the area? How have the angles changed? What differences do changes to angles make to shapes?

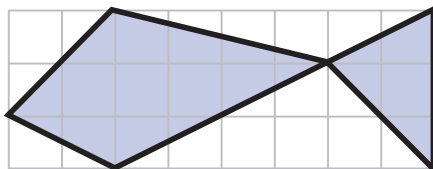
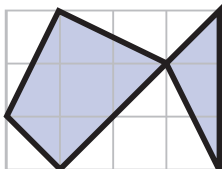
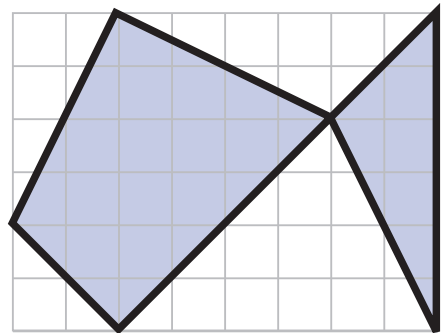
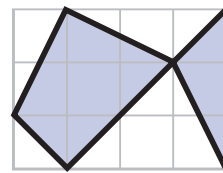

## Later ✓✓

### Flags

Have students each make a transparency of a simple geometric flag design. Use an overhead projector to project their designs onto large sheets of paper and, in some cases, turn the projector so that it is at an angle to the wall, distorting the image. Invite students to trace around their images so that each student has their original design and its enlargement (or, in some cases, its distorted enlargement). Have students compare the original transparencies with the copies. Ask: What is the same? What is different? Have you considered angles, lengths and area? (see Sample Lesson 2, page 40.)

### Hexagons and Trapeziums

Extend the Middle Sample Learning Activity 'Triangles and Other Shapes' by having students use pattern blocks to make enlarged copies of the hexagon and trapezium, doubling and tripling the dimensions. (You will need to use triangles to complete the enlarged shapes.) Ask: If you make a larger hexagon by doubling the dimensions, how many of the small hexagons would match the area of the larger hexagon? What about if you triple the lengths of the sides? Can you predict how many of the small hexagons will match the area of the tripled hexagon? How does this fit with what you know about doubling and tripling other shapes? Will this work with trapeziums?

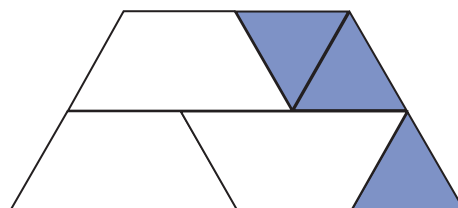
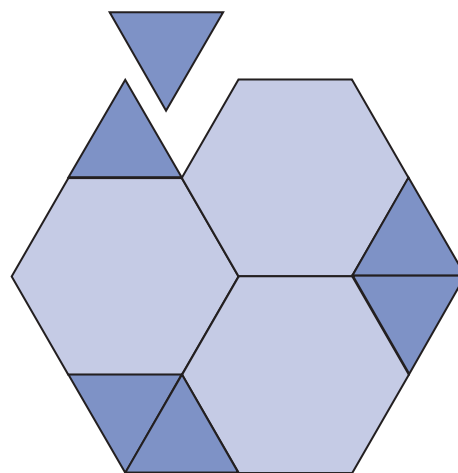
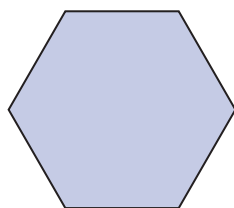
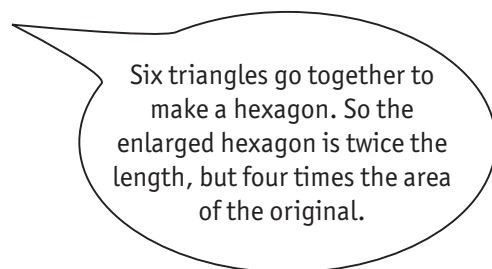

**Using a Photocopier**

Have students draw a curved, closed shape on a sheet of paper (like a curvy puddle), then enlarge (reduce) it for them on a photocopier using an enlargement (reduction) ratio of their choice. Invite them to compare their original with the copy. When comparing matching lengths, ask: How does it relate to the enlargement (reduction) ratio? Have students use grid paper to work out the area of each shape. Ask: How does the change in area relate to the enlargement (reduction) ratio?

**Chair Factory**

Extend Middle Sample Learning Activity 'Chair Factory' by tripling the linear dimensions. Record the number of pieces in the original chair and the enlarged chair. Produce a table of the whole class's results. Ask: Is there a consistent relationship between the number of blocks in the original chair and the number in the tripled chair? (Link to **First Steps in Mathematics: Number**, Reason about Number Patterns, Key Understanding 2.)

## SAMPLE LESSON 2

**Sample Learning Activity:** Later—'Flags', page 38

### Key Understanding 2:

When two things have the same shape:

- matching angles are equal
- matching lengths are proportional
- matching areas are related in a predictable way
- matching volumes are related in a predictable way.

**Working Towards:** Levels 4 and 5

### Teacher's Purpose

My Year 7 class had been enlarging and reducing figures using grids and had become quite skilled at it. They knew that on their grid enlargements each line increased in the same ratio and the angles did not change. Using grids meant, however, that the enlargement factors were always numbers like 2 or 3 or  $1/2$ —a highly structured situation. I was not convinced that students really understood what it meant to be the same shape mathematically and how this related to 'looking right' for enlargements and reductions.

### Motivation and Purpose

Several days earlier, students had produced a simple flag design and I had given each of them a half-sheet of acetate to draw it on so they could show it to the class enlarged using the overhead projector. The day before my planned lesson, I turned on the overhead projector, and one at a time throughout the day, students put their flag on the projector, then traced the image produced on the wall onto sheets of butcher's paper, which I had pinned up. The idea was that this would act as the template for making an actual flag in their art and technology lessons. During the day, I casually moved the projector so that the size of the images varied, but sometimes I pulled it around so that it was not 'square' with the wall and so produced a distorted image. My students sat in groups, and I made sure that there was a mix of 'proper' enlargements and distortions in each group of students.

*My intention here was to provide some conflict for students as the distorted images would not have matching angles equal and matching lengths proportional. Distorted images are not the same shape.*

### Connection and Challenge

The next day, I asked the students to get out the small (transparency) and large (butcher's paper) copies of their flags and asked the apparently simple question, 'What stays the same and what changes?'

Students volunteered such things as, ‘They look the same, but different sizes’ and, ‘The sides all go up the same amount.’

I asked them to think about the enlargements we had done with grids and the sorts of things we had investigated there. They suggested angle, length, number of squares, area. I wrote these on the board. I then challenged the students to systematically investigate the relationship between the small and large versions of their flag so that they could report to each other.

### Action and Reflection

My students were used to such activities and quickly started working. Because the original was on a transparency, they compared matching angles easily by superimposing.

‘Be very accurate,’ I said occasionally.

‘Are you sure?’ I asked, when students started immediately to say that the angles didn’t change.

Within a few minutes, one or two students who had the distorted versions started to get uneasy, although a couple of others did not notice—either because they checked too few angles or because they were a bit casual with their superimposition and their distortions were not too great. I spoke quietly to some who were concerned and suggested they mark the angles that were equal and those that were not.

Although they had not finished with lengths and area, I drew the class together to talk about angle. ‘What did you find?’ I asked.

Immediately students started to volunteer that the angles were ‘the same’. There was a chorus of agreement. I turned to one of the students who I knew had a distortion, ‘Yolanta, do you agree?’

‘Sometimes,’ she said.

When I asked her what she meant, she held up her butcher’s paper, pointed in turn at several angles and said, ‘These were close but these were bigger.’

‘Well,’ I challenged them, ‘you seem confident that the angles must stay the same, but Yolanta says hers weren’t. Who is right?’

A number of students then suggested that Yolanta’s copying may have been poor, or her measuring, to which Yolanta objected. I asked Yolanta to hold up her original and her enlargement and as she did so she commented that it didn’t look right, but she had copied it properly. I then asked whether any one else had found what Yolanta found and whether their copies also looked odd. A number of other students offered their own examples.

*Is there a relationship between matching angles on your two versions? If there is, what is it?*

*Is there a relationship between matching lengths on your two versions? If there is, what is it?*

*Is there a relationship between matching areas on your two versions? If there is a relationship, what is it?*



I then relented and asked Yolanta to bring her transparency to the front. We put it on the overhead projector and I asked the class to watch carefully. I began with the projector correctly positioned in front of the wall and then gradually moved it at an angle. The image on the wall changed shape; that is, it became more and more distorted. As the students began to realise what had happened, I owned up that I had 'set them up' by moving the overhead projector the day before.

### Drawing Out the Mathematical Idea

I then spent some time drawing out from the students that the point of an overhead projector was that what was on the screen should 'look the same', only bigger, and that things 'look the same' when they have the same shape. If they do not have the same shape, they look distorted (odd, lopsided, 'skew-whiff').

I then asked the students to look at their group's enlarged flags and decide which ones looked right (the same shape) and which looked distorted. We then went around the groups one at a time and found that, as a rule, it was the people who had distorted copies who had found that their angles did not quite match. We drew this together:

If two figures have the same shape, matching angles will be the same.

If matching angles are not the same, the figures are not the same shape.

### Connection and Challenge

I then asked students to return to investigating the original question about length but taking into account which butcher's paper flags were enlargements and which were distortions.

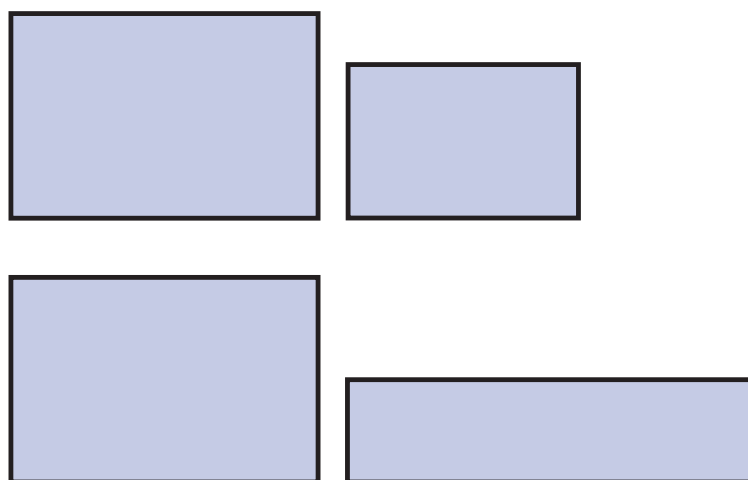

*One of the difficulties for students here is that they will often have formed the mistaken idea that all figures in a given class have the same shape; for example, they may think that all rectangles are the same shape.*

*This casual use of the term 'same shape' can be quite confusing. We often refer to all rectangles as the same shape, but really mean they are in the same class of shapes. The first two of these rectangles are the same shape but the second two are not.*

I suggested to students that they work out the ratios between matching lengths for six or seven different parts of the flag as accurately as they possibly could. They were then to decide whether they were all the same and whether there was a difference between the enlargements and distortions.

Most were fairly confident that all the lengths would increase 'by the same amount', but this did not always translate into knowing that they needed to calculate a ratio—that is, to divide. Measuring, deciding what calculation to do and calculating accurately in order to find the ratio between matching lengths was a challenge for many students. This became the topic of the next few lessons ...

*For figures to be the same shape, the following must both be true:*

- *matching angles must be equal*
- *matching lengths must be in proportion.*

**KEY UNDERSTANDING 3**

*Scale drawings and models have the same shape as the original object. This can be useful for comparing and calculating dimensions and for making judgments about position.*

As suggested for Key Understanding 2, when two figures or objects have the same shape, we can predict the relationship between matching lengths, areas and volumes on the two shapes. It is these mathematical relationships that make scale drawings, plans, maps and models useful. A scale model of the 3D object will look like the original, only smaller or bigger, and similarly, a scale drawing of a 2D figure will look like the original. Often scale drawings give us 2D 'snapshots' of 3D things, however. For example, maps and plans give a 'bird's eye' view and only represent some features of the real thing. (This is also addressed in Space: Represent Location.) The focus of this Key Understanding is on the measurement involved in interpreting, using and making scale drawings and models.

In the early years, there is little distinction between this Key Understanding and Key Understanding 2. Students should build on their intuitive ideas about scale with the emphasis being on what 'looks right' but is bigger or smaller. For example, students may match component parts according to a rough scale (e.g. *This chair is for the baby bear*) and attempt to make models of familiar things, discussing how they could make it look right (e.g. *It doesn't look right because the wheels are too small for the car*). Later, they should build scenes (e.g. dioramas, model farms, dolls' houses) to an intuitive scale, also asking whether it 'looks right' and, if not, deciding how to improve it.

During the middle and later years, there should be a gradual development from a very intuitive feeling for scale to the somewhat more formal use with whole numbers or unit fractions as scale factors. There are two aspects to this Key Understanding. Firstly, students should learn to interpret and use the information provided by scale drawings, plans, maps and models to make decisions such as whether the house will fit on the block, how far it is between the

two towns, what the shortest route is and if, on average, a man is 1.8 metres tall, about how tall that building is likely to be.

Secondly, students should produce scale drawings, plans, maps and models in order to provide information to others and to make decisions about such things as the arrangement of furniture in their classroom, stage props for their play or how a flag design they have in mind will look when made. They should attempt to make accurate scale drawings of simple figures and objects, such as a plan of the school to provide to visitors, or a storage box. In order to produce a scale drawing or model, they will need to decide what measurements to take on the original. This may require them not only to consider lengths but also angles. It is important for students to have the opportunity to make such decisions for themselves so that they learn what can go wrong when you take insufficient or unhelpful measurements.

Students at Level 3 attend to scale informally when interpreting and producing maps, plans, drawings or models. They realise that they can get a sense of comparative distances and lengths from maps, plans and models produced by others. When producing their own, they attempt to get things 'looking right' by adjusting sizes.

At Level 4, students use simple scale factors to calculate and estimate measurements. For example, given a picture or object and asked to 'make it three times as big' or 'one-third as big', they work out the size of the parts in the scaled version. They also work out what measurements to take when making straightforward scale drawings, maps or plans.

At Level 5, students can calculate the scale factor between two different-sized versions of a figure or object. They can also use data in a map, plan or photograph together with their everyday knowledge to estimate scale factors and use the data to answer other questions about the objects represented.

## SAMPLE LEARNING ACTIVITIES

### Beginning ✓

#### Model Farm

Give students a 3D model of a town or farm that has some parts of it to scale and others not. For example, in a model farm, include a plastic duck that is as big as the shed, and a model tractor that is as small as the dog. Alternatively, ask students to use junk materials to construct their own models. Ask students to identify what 'looks right' and what doesn't. Ask: Why do some things look the right size and others don't? How could we fix those parts that don't look right? Encourage comparative language (e.g. *the tractor has to be bigger than the dog because real tractors are much bigger than real dogs*). (See **First Steps in Mathematics: Space**, Represent Transformation, Key Understanding 3.)

#### Teddy Bear

When students are illustrating stories such as 'The Three Bears', give them a teddy bear to copy. Before drawing, focus the students on the shapes they can see in the ears, face, body and legs. Ask students to draw Father Bear first, then to redraw it smaller to be Mother Bear and smaller again to be Baby Bear. Ask: What did you need to think about when you made Mother Bear's and Baby Bear's heads? What about the ears? How are they different on Baby Bear? What is the same about the ears in all three drawings? (Link to **First Steps in Mathematics: Space**, Represent Transformation, Key Understanding 3.)

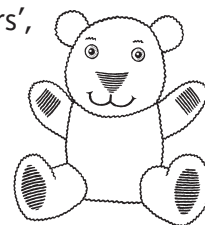

#### Different Sized People

Show two small models of different sized people and ask students to find various 'pretend' items that are the right size for each model to use. For example, ask: Why would this marker lid make a good glass for this person? Why do you think it would be too small for that person? Would the thimble make a good wastepaper basket? Why? Why not?

#### Classroom Plan

Have students draw bird's eye view plans of the classroom to show different possible arrangements of desks. Ask them to first build a 3D model using blocks or building bricks for furniture, then develop a 2D plan from their model. Ask: Would there be enough room to walk between your desks? Should the desks be larger or smaller than the computer bench? Why isn't there enough room on your plan for all the desks in the room? What could you do to fix it? (See Sample Lesson 3, page 52.)

## SAMPLE LEARNING ACTIVITIES

### Middle ✓✓

#### Making Models

Give students 'junk' material to make models of familiar structures (e.g. towers, robots, houses, bridges). Ask them to think about the relative size of parts of their models. For example, prompt their thinking by asking: If the house is this big, how big do you think the window should be? How big would the door be? Does it look right? Why? Why not? What would you do to fix it? (Link to Key Understanding 2.)

#### Spiders

Ask students to imagine they are a spider on the ceiling of their classroom looking down. Ask: What do you think the top of the desks would look like? What about the bookcase and the cupboards? Do you think you could see the legs of the desks? Have them draw a plan of the classroom as they think the spider would see it. Ask: What 'looks right' on your plan? Does anything look strange? (e.g. *My plan looks like the classroom but it is a bit funny because I have drawn the teacher's desk too big for the other furniture.*) (Link to **First Steps in Mathematics: Space**, Represent Location, Key Understanding 2.)

#### Informal Scale Models

Have students make models to a specified but informal scale. For example, give students a box and say: This is a table. Make a chair the right size for this table. Ask: Why did you decide to make the legs that high? What other measurements did you have to think about to make the chair the right size? (Link to Understand Units, Key Understanding 1.)

#### Scale Factors

Have students investigate simple scale factors on maps (e.g. 1 centimetre = 1 kilometre). Ask: What does this mean? How can I use this to work out how far it is from Melanie's house to the video shop? Invite students to work out approximate lengths and distances using simple scales. (Link to Understand Units, Key Understanding 6.)

#### Scale Models

Have students use uniform units (e.g. straws, popsticks) to measure given features of the environment (e.g. the width, length and height of furniture or playground equipment). Ask them to make models of the measured features, using 1-centimetre or 2-centimetre cubes to represent one unit. Encourage students to explain the scale they have used. Ask: How do you know that the table should be three blocks tall? How many straws long was the playground tunnel? So, how many blocks long will it be in your model?

## Middle ✓✓

### More Classroom Planning

As a whole class, have students help measure the length and width of the classroom and the fixed furniture around the room. Draw a one-tenth scale plan (1 decimetre = 1 metre) of the classroom, including only the fixed furniture, on a large sheet of paper. Help students measure and make correctly scaled cardboard cut outs of their desks and chairs, as well as other moveable furniture. Invite them to position their cut outs on the classroom plan to show how the furniture is currently arranged. Later, have students re-position the furniture on the plan to help work out a new arrangement of furniture for the classroom. Ask: Have you left enough space between your desks? How do you know? Will there be enough room to walk between those chairs? (Link to **First Steps in Mathematics: Space**, Represent Location, Key Understanding 3.)

### On the Computer

Have students investigate reducing and enlarging print on the computer in order to predict and check scale changes. Ask them to type the same word a number of times using the same font. Invite them to change each one to a different point size, record the size of each one next to it, and print the sheet. Have students hand their sheet to a partner and ask, *How much bigger or smaller have I made my word?* Encourage students to predict whether it is, for example, twice as big, three times as big, half as big. Ask: How do you know? What effect does the different point size have on the size of the print? Is a 40-point word twice the height (width) of a 20-point word? (See **First Steps in Mathematics: Space**, Represent Transformation, Key Understanding 3.)

kitten 10 pt

kitten 20 pt

kitten 40 pt

## SAMPLE LEARNING ACTIVITIES

### Later ✓✓

#### Floor Plans

Have students examine the floor plans of houses and identify some rooms to work out the scale used. Invite them to use the sizes indicated on the plan for each room to measure out the actual dimensions on the playground. Ask: How many square metres is the games room in real life? What are the measurements on the plan? How can you work out what scale the architect has used to draw the plan?

#### Distorted Simple Shapes

Ask students to examine two drawings made up of simple shapes, one supposedly an enlargement of the other but with some distortions so that it doesn't 'look right'. Ask: Which parts of the enlargement look right? Which parts do you think are distorted in some way? How can you tell? Invite them to use grid lines to discover exactly what is wrong and then attempt to correct it. Ask: What do you need to do to correct the roof? How have the windows changed? (Link to *First Steps in Mathematics: Space*, Represent Transformation, Key Understanding 3.)



#### Athletics Banner

Invite students to design a banner using a scale drawing. For example, say: The Australian Athletics team needs a new banner to take to the World Athletics Championships. The banner has to be 4 metres by 2 metres and include the words 'Australian Athletics Team'. Make a scale drawing of it so the manufacturer knows exactly how to make the full-sized banner. Ask: Why is it important to tell the manufacturer the scale used to design the banner? (Link to Key Understanding 4, and Understand Units, Key Understanding 6.)



## Later ✓✓

### Dolls and Action Figures

Ask students to bring in dolls and action figures. Invite them to compare the height of the doll to their own height and find how many times the doll's height would fit into their own. Have them use this scale factor to compare other body measurements (e.g. waist, length of limbs). Ask: If your height is ten times the height of the doll, what would you expect the doll's waist measurement would be? How can you check? What other measurements are different from what you would expect? Why do you think dolls are not accurate scale models of real people? What about toy animals? Are they also distorted models of real animals? How? Why?

### Micronians and Earthlings

Say: The inhabitants of the planet Micros look exactly the same as humans, but their forearm bone is only 10 centimetres long. Ask: Can you use this information to work out how tall they are? Ask students to draw a picture to scale that shows an Earthling standing next to a Micronian. Ask: What other measurements do you need to make to complete the drawing? How can you use the information you have about the Micronian's forearm to decide how long its legs are? Help students see that by dividing the length of their own forearm by 10 centimetres (the length of the Micronian's forearm), they will arrive at a scale factor that tells them how many times longer their legs (waist, chest, hands) are than the Micronian's. (Link to **First Steps in Mathematics: Number**, Understand Operations, Key Understandings 3 and 4.)

### Cereal Boxes

Have students compare the picture on the front of small and large cereal boxes. Ask: What has remained the same? What has changed? Invite students to draw a grid across the front of the smaller box, and create a smaller version of the same box. Ask: What scale factor have you used? (See Understand Units, Key Understanding 2, and **First Steps in Mathematics: Space**, Represent Transformation, Key Understanding 3.)

### Scale Drawing of the School

Give students a scale drawing of the school and ask them to work out the scale factor used. Invite them to measure different parts of the school and compare their measurements to measurements taken directly from the drawing. Ask: How have you compared the two measurements? How can your calculator help you compare? Which operation did you use to work out the scale factor? How can you check that you have the correct scale factor for the drawing? (Link to **First Steps in Mathematics: Number**, Understand Operations, Key Understandings 3 and 4.)

**Display of Artwork**

Have students use scale drawings to plan arrangements of objects. For example, say: We need to help the librarian set up a display of winning artwork from the artwork competition. Two of the winning pieces are 30 centimetres by 21 centimetres and the other two are 60 centimetres by 42 centimetres. The pin board is 1.5 metres by 2 metres. Encourage students to choose a simple scale (e.g. 1 millimetre = 1 centimetre) to draw the pin board and make cut outs of the winning pieces to experiment with arrangements. Then, invite students to choose a suitable arrangement and use the scale plan to set up the full scale display in the library. Ask: What is the same and what is different in the scale plan? What do you need to measure to be sure the winning pieces are set up as planned? (Link to Key Understanding 4, Understand Units, Key Understanding 6, and **First Steps in Mathematics: Number**, Understand Operations, Key Understandings 3 and 4.)

## SAMPLE LESSON 3

**Sample Learning Activity:** Beginning—‘Classroom Plan’, page 46

**Key Understanding 3:** Scale drawings and models have the same shape as the original object. This can be useful for comparing and calculating dimensions and for making judgments about position.

**Working Towards:** Level 3

### Motivation and Purpose

My Year 3 class had talked about how we could rearrange the classroom and I decided to use this to develop ideas about scale. I asked the students to make a desktop model of how they would like the classroom to look.

### Action ...

A few chose wooden cubes to represent desks, but most decided that Lego™ pieces were better. Several chose a sheet of paper to use as the floor and some drew in furniture around the room before counting the correct number of Lego™ ‘desks’. I showed the rest of the class what they had done and suggested that they could all draw a plan of their classroom layouts.

Students chose the size of paper they wanted to use and many started by using the Lego™ pieces as templates to draw around so that all of the desks would be the same size. Others put the Lego™ pieces away before they began their plan and seemed to not consider the size of the pieces of furniture as they drew them in. Quite a few ran out of ‘floor space’ before they’d drawn in all the desks, and decided they’d have to start over with a larger piece of paper. Re-drawing smaller desks was not the obvious solution for them. Others had drawn in very small desks and so ended up with lots of floor space in their plans. No one used any form of measurement in drawing up their plans.

### ... and Reflection

I drew the students together and asked, ‘Is there enough space on your plan for people to walk around the room between the desks? Everyone in the room has to be able to get to the door easily.’

I asked them to use their plan and show their partner how people would walk to the door. Many students realised they hadn’t considered the space between the various pieces of furniture. Some realised that they had made some pieces bigger or smaller than they should have. I could hear comments

*I wanted the students to think about the size of the various pieces of furniture in relation to each other and to the size of the room.*

from students saying things like, 'But the teacher's desk is not that big really, it's just a bit bigger than our desks.' 'All of your desks are kind of squashed up in the corner and there would not be enough space for chairs.' 'I couldn't fit through that gap, it's too small.'

### Drawing Out the Mathematical Idea

After a while, I called them all together again and said, 'When we draw a plan, we really need to try to have things about the right size.'

I drew a rectangle on the white board and asked, 'If this is the size of one desk in our room, how big should the computer table be? Bigger than it or smaller than it? How much bigger than it?'

I asked everyone to show me with their hands and then asked Tadao to draw it. We discussed whether this was about the right size and after a small correction I asked, 'If this is the size of one desk in our room, then how big should my desk be?'

Again, the students indicated with their hands, and one student drew the picture.

'OK, now look at your plan. Is the computer table about the right size in comparison to one desk that you have drawn?'

At this point, many of the students seemed concerned that their plan was 'not right' so I offered them the opportunity to try again.

*It was time to draw out the importance of trying to keep things to scale.*



Corey's plan of the classroom

*Several students did not attempt the conventional 'bird's eye' view. They drew the desks with the legs showing and included the wall displays and blackboard, as well as students sitting in their chairs and the teacher walking around, as in Corey's plan below.*



Katlin's plan of the classroom

*Katlin's plan is typical of the plans initially produced by most other students. They used a conventional bird's eye view, but most did not attend to the relative size of furniture or space between the desks.*

## KEY UNDERSTANDING 4

*We can calculate one measurement from others using relationships between quantities.*

In the everyday world, many of the measurements we use have not been obtained directly but have been derived from other measurements by undertaking calculations. This may involve:

*choosing and using an operation, such as:*

- adding the quantities shown on each of the packs to decide how much mince there is in the freezer
- weighing ourselves on the bathroom scales, weighing ourselves holding the cat, and find the difference to find the weight of the cat
- measuring the thickness of a thousand sheets (a ream) of paper and dividing the measurement by one thousand to measure the thickness of a sheet of paper

*choosing and using a rate or scale, such as:*

- finding the volume of a container by finding the mass of the water it holds, and using the fact that water weighs one gram per cubic centimetre
- estimating the time it will take to travel between two towns using the anticipated speed (a rate) and the distance
- using a measurement on the map, and the scale factor of 1000 to estimate a real distance

*choosing and using a formula, such as:*

- finding the area of a rectangle by measuring the lengths of two adjacent sides and multiplying the two measurements
- using a baby's weight and a formula relating the amount of medicine needed to body weight to work out the right dose of medicine.

Students should learn to recognise when a calculation would help solve a practical measurement problem, work out which calculations to do and do them correctly.

Working out whether and when a calculation is possible involves thoughtfulness and judgment. For example, students may have learned through activities such as those described in Key Understanding 1 that the area of a rectangle can be found by multiplying its length by its width. Confronted with the problem of finding the area of a garden bed, they then have to decide whether they can use this rule or formula. *Is the garden a rectangle? Can we check? Is it close enough for my purposes? If not, can I break the region up into smaller rectangles that I can find the area of?* and so on.

If the students decide that a particular formula may be used, they will need to decide what component measurements are required and apply the formula correctly. Applying the formula correctly is not simply a matter of computational skill (which is dealt with in Number: Calculate), it involves first checking that the units of measurement are appropriate and doing any needed conversions.

Students who have achieved Level 3 can choose operations in relatively straightforward situations. For example, they may add the lengths of the sides of a shape to find its perimeter, or subtract a TV program starting time from its finishing time to work out if the three-hour videotape is long enough.

Students who have achieved Level 4 can carry out calculations with measurements involving decimals. They use the relationship between quantities to work out one quantity from another and will make some of their own measurement short cuts. For example, they might multiply the length of one side of a regular polygon by five to get the perimeter or find the volume of a prism composed of cubes by multiplying the number of layers by the number in each layer.

Students who have achieved Level 5 can choose and use straightforward formulae with which they are familiar, including working out what measurements they need to make in order to use the formula and ensuring that the units are consistent.

## SAMPLE LEARNING ACTIVITIES

**Beginning** ✓**Incidental**

Let students see and hear your calculations when you combine measurements for a purpose. For example, while planning the assembly, say: We will allow about 2 minutes for the speech by Ms James and 3 minutes each for the two songs, so that is 8 minutes so far. Or, say: We are going to need two cups of starch for each batch and there will be three batches, so we will need six cups of starch.

**Does It Work?**

After students have used a common unit to measure the length of various paper tapes or ribbons, ask them to predict the total length if they were to be arranged in a long line. Ask: What would we need to do to work out the total length? Would your calculator be helpful? Have them check their calculations by laying out tapes (ribbons) end-to-end and measuring the total. Repeat for other combinations of lengths. (Link to Direct Measure, Key Understanding 3.)

**Class Party**

Invite students to solve problems that involve combining quantities. For example, say: In preparing for the class party, Mrs Williams poured one cup of cordial into the jug and then added nine cups of water. Ask: How much drink did she make? How do you know it is that much? What if she wanted to make double that amount? How many cups of cordial and how many cups of water would she need? How did you work it out? (Link to **First Steps in Mathematics: Number**, Understand Fractional Numbers, Key Understanding 7, and Understand Operations, Key Understanding 3.)

**Cooking**

In cooking activities, involve students in planning the quantities and writing out new recipes. (e.g. doubling the ingredients for a cake, making enough dough for two scones for each student, calculating the ingredients for home-made lemonade from a recipe for four) (Link to **First Steps in Mathematics: Number**, Understand Operations, Key Understanding 3.)

## SAMPLE LEARNING ACTIVITIES

### Middle ✓✓

#### Excursions

Have students help plan excursions. For example, invite them to work out when they will return to school. Ask: How long will we spend at the destination? How long will it take to get there? How long will it take to get home? How long will we spend having lunch or snacks? Help students see how periods of time are combined and related to the starting times to enable them to tell parents when they will return to school. (Link to Direct Measure, Key Understanding 6.)

#### Friezes

Have students work out the length of a border for the pin board. Encourage them to decide on a suitable unit, count how many on each side and attach that number to each side. Ask: What do you notice about the top and bottom and side measurements? Invite them to work out the total length without re-measuring. Ask: Can you see a short cut for measuring another pin board?

#### Frame a Picture

Invite students to work out how much card they need to frame their art. Ask: What measurements will be needed? How will the corners go together? Will this make a difference to the measurements? How can we work out how much wood (card) will be needed altogether? It comes in lengths of 1 metre, 1.5 metres and 2 metres. Which would be the best to use? Have students measure and construct their frames. (Link to Direct Measure, Key Understanding 4.)

#### Overcoming Limitations

Have students overcome limitations in the measurement range of equipment. For example, give students kitchen scales that weigh up to 250 grams. Ask them to find the mass of a bag of flour (which weighs more than 250 grams). Then, ask them to find about 400 grams of tomatoes to use in a sauce. Ask: What calculations did you need to do? How can you check your results a different way? (Link to Direct Measure, Key Understanding 4.)



## Middle ✓✓

### Broken Ruler

Ask students to measure and calculate to overcome inaccuracies in equipment. For example, give students parts of a broken ruler (they should have different parts) or paper tape marked like a broken ruler. Ask them to find the length of both shorter and longer items and say how they were able to measure in centimetres. Ask: How can you work out the length without having to count each centimetre gap? What calculations can you use? Which measurements involved more calculations? Why? Does it matter which part of the ruler you have? Should you get the same result? (See Direct Measure, Key Understanding 4.)

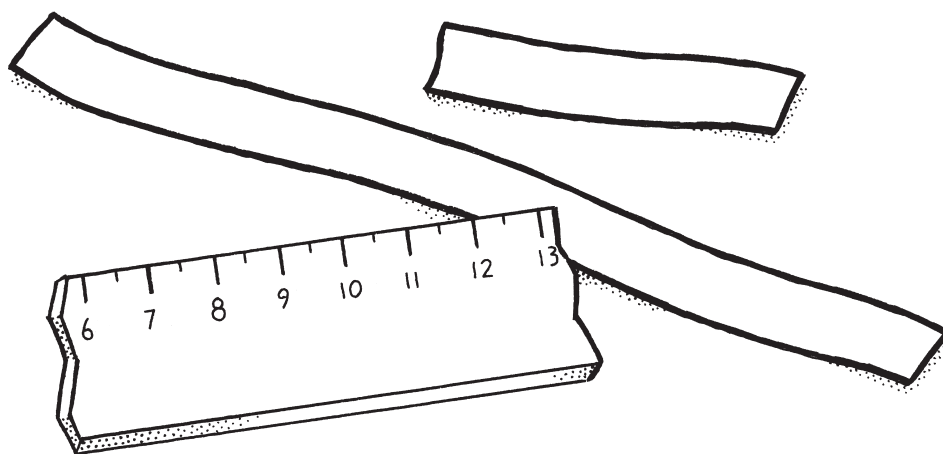

### Combined Mass

Ask students to find objects that have a combined mass of 1 kilogram (combined length of 1 metre). Ask: How did you do this? Did you need to use any calculations? How did you find out how much the last object had to weigh (measure)? Was it difficult to find something that was just right? (Link to Estimate, Key Understanding 2.)

### Weighing Awkward Objects

Have students use bathroom scales to find the mass of objects that can be difficult to weigh without special scales (e.g. small animals, bags of fruit or vegetables, a packed suitcase) by weighing themselves, weighing themselves together with the object, then calculating the difference. Ask: Why does this method work? How accurate is it likely to be? Could we weigh a very tiny kitten using this method? Why? Why not? (Link to Direct Measure, Key Understanding 4, and Understand Units, Key Understanding 5.)

## SAMPLE LEARNING ACTIVITIES

### Later ✓✓✓

#### Recycled Cans

Have students investigate how much the school receives for recycled aluminium cans. Invite them to use this information to calculate the total mass of the cans collected by their class so far, the total mass of cans collected in the school, the amount of money the school will receive and a prediction of how much money the school will receive by the end of the year. Ask: How can you work out the total mass when you can't fit all of the cans on the scales? What do you need to know to work out how much money the school should receive? (Link to **First Steps in Mathematics: Number**, Understand Operations, Key Understanding 3.)

#### Overcoming Limitations

Invite students to find a way to measure things that are too small for the accuracy of the equipment available (e.g. the thickness of a single piece of paper using only their ruler, the mass of a grain of rice using kitchen scales, the volume of a drop of water using a measuring cylinder). Compare the methods and the operations used for each measure. Ask: Which were the quickest and easiest to carry out? Did the different methods produce different answers? Why did this happen? How could the range be reduced? (See Understand Units, Key Understanding 5; link to **First Steps in Mathematics: Number**, Understand Operations, Key Understanding 4.)

#### It Needs Fixing

Ask students to calculate to address inaccuracies in equipment. For example, say: Our tape measure has stretched, so when I use it to measure an object that my stretched tape shows is 1 metre long, I know that the real length of the object is 1.2 centimetres longer than 1 metre. Ask:

- What would the real length of the room be if my stretched tape measure shows it as 4 metres long?
- What would be the real length of a chair that my tape measure shows as 50 centimetres?
- What would be the real length of my desk that my tape measure shows as 1.50 metres?

Have students share the calculations they used to work out the real lengths. (See Direct Measure, Key Understanding 4.)

## Later ✓✓✓

### Dripping Tap

Have students measure the quantity of water wasted from a dripping tap in one day. Ask: Is there any way we could work it out without leaving the bucket under the tap all day? How could we use this information to work out how much water would be wasted in a week? Invite students to work it out. Then, ask: Which measurements did you need to make? What calculations did you need to do? How could you adjust the time measurement to make the calculations easier? (Link Understand Units, Key Understanding 6.)

### Oil Spills

Have students find the areas of a range of irregular regions (not given on grid paper), such as the aerial view of oil spills. (See Middle Sample Learning Activity 'Oil Spills' in Key Understanding 1). Limit the materials students can use to paper tiles, ruler, pencil and calculator. Invite students to explain how they worked it out. Ask: How can you use the length-by-width rule to avoid counting all the squares? (Link to Direct Measure, Key Understanding 3; see Sample Lesson 4, page 64.)

### Using Perimeter

Extend 'Oil Spills' by having students test the incorrect hypothesis that you can use the perimeter of a region to work out the area. For example, present the following conflict situation. Say: Someone in the other class found a very quick and easy method to work out the area of a diagram of an oil slick. They taped string around the edge of the shape then cut and joined the ends of the string. They then made the string into a rectangle, and multiplied the height and the width measures of the rectangle to work out the area. Ask: Do you think this method would give you a measure of the area? How do you know? How could you test this? How would you convince the student from the other class?

### Using a Formula

Have students decide when it would make sense to use a particular calculation or formula and when it wouldn't. For example, present the following problems and ask: Would it make sense to multiply 4 by 10 to get an answer? Why? Why not?

- A man can run a kilometre in 4 minutes. How long would it take him to run 10 kilometres?
- A kilogram of apples costs \$4. How much would it cost for 10 kilograms?

Present the following questions and ask: Could you sensibly use the length-by-width rule to answer the following questions? Why? Why not?

- The school oval measures 70 metres by 50 metres. What is its area?

- A rectangular paddock measures 70 metres long and 50 metres wide. What is its area?
- A rectangular park is 70 metres long and 50 metres wide. How much fencing will be needed to enclose it?

Show students the following shapes and ask: why wouldn't it make sense to multiply 7 times 8 to find the area of these shapes? (Link to **First Steps in Mathematics: Number**, Understand Operations, Key Understanding 9.)

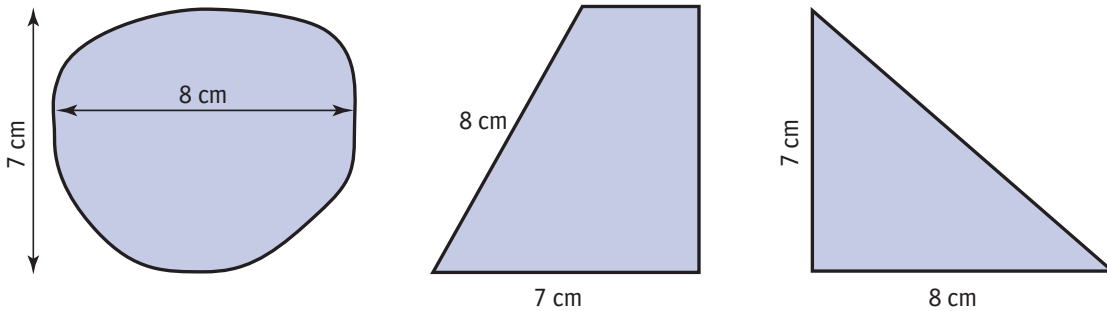

**Grazing Areas**

Say: There are two goats. The first goat is tethered by a lead to a stake in the ground. The second goat is tethered by a lead half as long as the first goat's lead to a sliding rail that is double the length of the first goat's lead. Invite students to use a compass and ruler to draw representations of the two feed areas. Give students cubes, paper tiles, or pencil and ruler to work it out and then ask: How did you work out which animal has the larger grazing area? Encourage students to discuss and justify the method they chose. Draw out the strategies that were the quickest and easiest to use. Ask: How do you know these strategies are as accurate as counting all the squares? (Link to Key Understanding 1; see Direct Measure, Key Understanding 2, and link to Direct Measure, Key Understandings 3 and 5.)

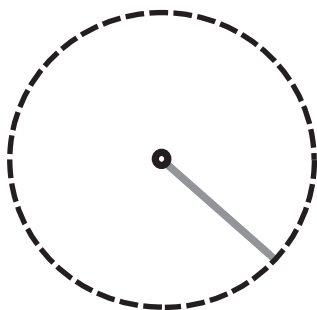

goat 1

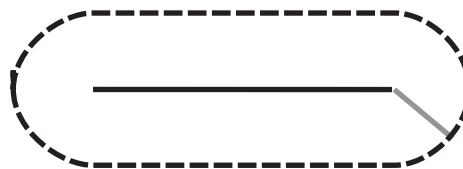

goat 2

## Later ✓✓✓

### Area Problems

Have students solve practical area problems involving regular and irregular regions (e.g. how much fertiliser needs to be purchased for the school oval, how much paint needs to be ordered to paint a large red circle on the bitumen using two coats). Encourage them to draw on a range of strategies, including partitioning into rectangles and other regions and adding areas, using formula, and so on. Ask them to explain and justify their strategies to their peers. (Link to Indirect Measure, Key Understanding 1, and **First Steps in Mathematics: Number**, Understand Operations, Key Understanding 3.)

### Postal Rates

Give students information about postal rates from Australia Post. Say: Franco wants to send some small gifts to Italy. They have a total mass of 1.4 kilograms and each weighs between 100 grams and 150 grams. Ask: What is the best way to send them? Invite students to investigate and compare sending them together in one parcel or separated into two or more parcels, by surface mail or airmail. Ask: How would your choices be different if the gifts had to get to their destination as soon as possible? (Link to **First Steps in Mathematics: Number**, Understand Operations, Key Understanding 3.)

### Missing Labels

Have students complete measurement problems by filling in the missing labels or measurement units for each answer and then justifying their choice. For example, ask: How do you know which unit is needed for these answers?

- What is the area of a 4 centimetre by 3 centimetre rectangle? 12 \_\_\_\_
- What is the volume of a 5 centimetre by 2 centimetre by 3 centimetre rectangular prism ? 30\_\_\_\_
- How far will I travel if drive at 95 kilometres for  $1\frac{1}{2}$  hours? 142.5\_\_\_\_
- The scale on the map is 1 centimetre = 5 kilometres. If the distance between towns on the map is about  $3\frac{1}{2}$  centimetres, what is the real distance between the towns? 17.5 \_\_\_\_

(Link to Understand Units, Key Understanding 7.)

### How Much Concrete

Have students solve area and volume problems in which different units are used. For example, say: Calculate how much concrete in cubic metres is needed to make a path 50 centimetres wide, 20 metres long and 50 millimetres thick. Would 1 cubic metre of concrete be enough or would you need 2 cubic metres? How did you decide? Encourage students to use diagrams and visualisation. For example, invite students to imagine how many layers of path would reach a metre tall. Ask: How can you compare the thickness in millimetres to a metre? (Link to Understand Units, Key Understanding 7.)

**Can You Do It?**

Have students work in pairs or groups to decide whether or not there is a single answer to questions like the following:

- If the area of the square of carpet is  $49 \text{ m}^2$ , can you work out the length of the sides?
- If the volume of a cube is  $8 \text{ cm}^3$ , can you work out its surface area?
- If the area of a rectangular swimming pool is  $18 \text{ m}^2$ , can you work out the lengths of the sides?
- If the volume of a rectangular prism is  $24 \text{ cm}^3$ , can you work out its surface area?
- The area of the paddock is 800 square metres. Can the farmer work out what fencing he needs?

Ask: How did you decide which could be answered? What calculations would you use? Why isn't a single answer possible for the other questions?

**Did You Know?**

Many students believe that you can work out the area of a shape from the perimeter. This is true for squares and for circles, but it is not generally true. It seems that students who have learned to think of area simply as 'length times breadth' will try to use it even when it does not help. For example, asked to find the area of an oil spill, quite a number of students in Years 5 to 7 placed a piece of string around the edge of the spill and then formed the string into a square or rectangle so they could use a formula to work out the area.

Students need many experiences that help them distinguish between the attributes of perimeter and area (see Understand Units, Key Understanding 1) and realise that one figure can have a bigger perimeter than another but a smaller area and vice versa. For example, have students:

- produce different figures all with the same perimeter and then put them in order by area
- produce different figures all with the same area and then put them in order by perimeter
- arrange various figures in order first by area and then by perimeter and compare the orders.

## SAMPLE LESSON 4

**Sample Learning Activity:** Later—‘Oil Spills’, page 60

**Key Understanding 4:** We can calculate one measurement from others using relationships between quantities.

**Working Towards:** Levels 4 and 5

### Teacher’s Purpose

I was glancing through the pointers to achievement at Levels 4 and 5 which suggested that students should be able to dissect irregular or ‘messy’ shapes into rectangles in order to find the area. My Year 6 students had measured things like leaves and puddles earlier in the year (developing their understanding of Direct Measure), but of late had mostly been using the length-by-width formula for rectangles. I wondered if they really understood what they were doing and why, and thought returning to irregular shapes might help them clarify when and how the formula could be used.

### Purpose and Motivation

A recent oil tanker accident resulting in a large oil spill had provoked an animated class discussion, so I decided to use that context as a basis for the area activity. The students were given a diagram of a large, irregularly curved, closed shape which couldn’t easily be approximated by a rectangle. I gave them the following scenario: ‘Here is an aerial view of an oil slick. The company needs a fairly accurate estimate of how much surface it covers to work out costs of treatment. What is the area of the oil slick?’

### Connection and Challenge

I made available 1- and 2-centimetre squares, but not square grid paper. I wanted to provoke the students into using a strategy other than counting squares. Many students started placing 1-centimetre squares on their shape, but quickly realised this was going to be too much of a chore, so they started drawing 1-centimetre grid lines on their sheet. A few students started groaning about there being too many squares to count. At that point, I asked, ‘Can you find a shorter way to work it out rather than counting all the squares?’

### Action and Reflection

Many students did still choose to count the squares. Some students, however, seemed to be excited by the challenge of finding a shortcut.

About eight students around the room used the idea of drawing rectangles inside the shape. Some students, like Megan, drew a large and a small rectangle over the grid she had drawn and then multiplied the length and width to work out the squares in the rectangle. She then counted the whole and part squares outside the rectangles.

Here is an aerial view of an oil slick. The company involved needs to know how much surface it covers to work how it will treat the damage. What is the area of the oil slick?

Describe how you worked it out:

I worked it out by making 2 rectangles in the center of the shape and used length x width then then I counted up all the whole squares not inside the rectangles then I tried to estimate the half squares then I tried to glue them together and estimate to make whole squares

eg these 2 pieces would make a whole piece.

Megan's work sample

Other students, like Jessie, had drawn rectangles inside the shape first, then constructed the square grid outside the rectangles. They calculated the rectangle areas, added them and then counted the leftover squares.

Here is an aerial view of an oil slick. The company involved needs to know how much surface it covers to work how it will treat the damage. What is the area of the oil slick?

Describe how you worked it out:

I made squares and rectangles first and found L x W. Then I made cm boxes, which weren't all full so I put some together which the total came to 283cm

Jessie's work sample



*I knew it was common for students to think that if shapes have the same perimeter they also have the same area, and to apply area formula to any shapes. I made a note of these misconceptions to be dealt with in the follow-up lesson.*

Lori asked if she could use string. She carefully placed it around the edge of the shape, then formed the same length of string into a rectangle and used length by width to work out the area. Several others followed suit. John made his shape into a square and found the area of the square using the formula he knew.

Two boys had come up with a formula for irregular shapes like the oil spill. Their formula was perimeter times pi. They wanted to know if this was correct.

At that stage I drew the class together. I began by asking them to call out their estimates and I quickly wrote them on the board. There was a fairly big range. I asked the students how they could explain this, and whether the range was acceptable. Some were happy with the range, but a few thought that some of the suggestions were 'way off'. After some discussion, I drew out from them that some of the strategies we used might not have given as good an estimate as others.

This gave me the opportunity to focus on the strategies they had used. I started with the rectangle idea and suggested to the class that the other shortcut ideas would require another lesson to investigate.

I asked Megan to explain why she drew a rectangle on her grid. She showed the class her diagram.

'Well, if I drew the rectangle I could times the number of squares in each row by the number of rows using the calculator. Then I found another rectangle underneath and I did the same thing. Then all I had to do was just count the leftover whole squares, and count up the parts of the squares around the edge. It was easy.'

'So, you found that looking for an array in your grid made it quick and easy to work out how many square centimetres in your shape,' I added. 'Who else looked for arrays?'

Students who used a similar method to Megan showed their drawings. I focused their explanations on how they used the arrays.

I asked Jessie to explain how he worked his out because he had also used rectangles but his method was different to Megan's.

'Well, I couldn't be bothered drawing in all the squares. I knew that if my rectangle was 14 cm across and 12 cm down that's the same as saying 12 rows of 14 which is 168 square centimetres. I did the same thing with the other rectangles.'

Two others shared the way they worked out the area of the rectangle within their shape and how they dealt with the leftover squares.

## Drawing Out the Mathematical Idea

I asked, 'So what do you have to do to be able to use these shortcut methods?'

'Well, you have to look for rectangles on your grid and then see how many rows and how many columns you have, then you can multiply,' said Sharn.

'Well,' said Leia, 'you don't have to count all the squares in the shape and get mixed up if you do it like that.'

'You could draw a big rectangle over the whole shape and then take away the squares that aren't in the shape,' said Nathan.

Some students thought that was a good idea and said that they would try that next time.

'It's just easier if you know the area of a rectangle is  $L$  times  $W$ ,' said James.

I knew that we would need to do many more of these types of activities so that students who were still counting each square could come to believe in the more efficient way of working out area in their own time.

I closed the lesson by saying there were two important jobs to be done over the next few days. The first job was to test the string shortcut method and the perimeter times pi method to see if they worked.

The second job was to examine the range of answers to see if we could decide which answers we are going to accept as being in the correct range and to talk about how accurate we were and needed to be. In doing this, we would need to think about the scale of the drawing and what we would actually be able to tell the oil company.

## BACKGROUND NOTES

### Structuring Rectangular Arrays

In the Background Notes for Direct Measure (pages 161 to 165), the significance of an understanding of rectangular arrays for students' understanding of the way we measure area was highlighted. This is closely connected to the development of students' understanding of the use of formula for finding area.

Rectangles such as those in diagrams (a) to (k)\* should be presented to students. Use your judgment about whether this should occur over time or in a concentrated period, depending upon students' previous experience and present understanding. Each rectangle has its dimensions in centimetres. Begin with the rectangles that give the most graphic information about the subdivision of the rectangles and then gradually move to those that give less information. Give students a number of problems of each type of graphic representation, thus modelling the structuring process for them so that they can build their capacity to do it for themselves.

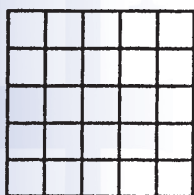

(a)



(b)



(c)

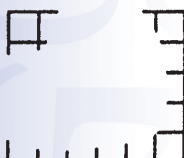

(d)

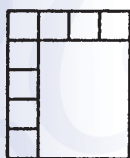

(e)



(f)

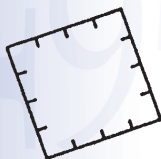

(g)

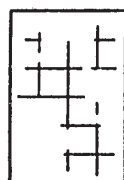

(h)



(i)



(j)

Students were shown that four square tiles go across the top (then the tiles were removed) and that three square tiles go down the middle (then the tiles were removed).



(k)

Students were shown that five square tiles go across the top (then the tiles were removed) and that seven square tiles go down the middle (then the tiles were removed).

\* Battista, M. 1999, The importance of spatial structuring in geometric reasoning, *Teaching Children Mathematics*, November, 170–177.

## CHAPTER 4

# Estimate

***Make sensible direct and indirect estimates of quantities and be alert to the reasonableness of measurements and results.***

This chapter will support teachers in developing teaching and learning programs that relate to this outcome:

### ***Overall Description***

Students have a good feel for the size of units, make sensible estimates in commonly used standard units, and have the disposition and skills to judge the reasonableness of estimates and measurements. They know that to estimate which of two rocks has the bigger volume, looking may be sufficient, but to compare their masses, hefting will probably be needed. They have a range of benchmarks that they use in estimation; for example, they may know which of their fingers is about a centimetre wide, what a litre container of milk looks like, and how heavy a kilogram of butter feels. They also use these benchmarks to judge the reasonableness of measurements and estimates, saying, for example, that the average height of students in their class simply cannot be 2.3 metres—they must have made a mistake. Students also reason from familiar or known quantities to estimate quantities that cannot be found directly or conveniently; for example, yearly water wastage from the school's leaky taps or how many apples are eaten in their state or territory each day.

Levels of Achievement	Pointers Progress will be evident when students:	
Students have achieved Level 1 when they make non-numerical estimates of size involving everyday movements and action.	<ul style="list-style-type: none"> <li>• make 'personal' estimates in moving and acting in their environment; e.g. <i>I think I am tall enough now to reach that light switch, or This will be too heavy for me to lift.</i></li> <li>• find things that are clearly bigger or smaller than an object</li> <li>• guess whether something will be longer than, shorter than, same length as a given thing and</li> </ul>	<ul style="list-style-type: none"> <li>• check by matching; e.g. when making a mobile, select a piece of tape they think will be longer than the one used before</li> <li>• find objects clearly heavier than, lighter than, about the same as a given object by hefting</li> <li>• use appropriately some of the everyday language associated with approximation; e.g. about, almost, nearly, not quite, just over, a bit under</li> </ul>
Students have achieved Level 2 when they estimate the order of things by length, area, mass and capacity and make numerical estimates of length using a unit they can see or handle.	<ul style="list-style-type: none"> <li>• attend to the right attribute when judging which of two things is bigger; e.g. attend to area rather than length when asked to say which mat would cover more of the floor</li> <li>• judge by 'looking' which containers will hold about the same as, more than, less than a given container, and by 'hefting' which objects will be about the same as, heavier than, lighter than a given object</li> <li>• judge which 'straight' and 'curved' things they can see have a length of about the same as, less than,</li> </ul>	<ul style="list-style-type: none"> <li>• more than a given thing, including a 1-metre or 1-centimetre length</li> <li>• estimate the number of times a unit of length that they can handle will fit along an object and show improvement in their estimates as a result of testing</li> <li>• estimate the time of day using natural or artificial phenomena; e.g. position of the sun, how full the school car park is</li> </ul>
Students have achieved Level 3 when they make sensible numerical estimates using units that they can see or handle and use language such as 'between' to describe estimates.	<ul style="list-style-type: none"> <li>• estimate, with a physical model of the unit available for comparison, which regions have an area of about, less than, more than a square metre, which containers have capacity of about, less than, more than a litre, which objects have a mass of about, less than, more than a kilogram</li> <li>• make sensible numerical estimates based on provided units; e.g. about how many gum nuts 'like this one' will fill the can</li> <li>• make informal statements about how confident they are in their estimates; e.g. <i>I am sure the wall is between 3 and 6 metres wide, pretty sure it is between 4 and 5, and think it is closer to 4.</i></li> </ul>	<ul style="list-style-type: none"> <li>• use the result of measuring with a physically present unit to try to improve their estimates with successive objects</li> <li>• use body parts and movements as a unit to help estimate length; e.g. know body parts and movements that are about 1 centimetre, 10 centimetres and 1 metre long</li> <li>• estimate the time of day, week or year using 'clues' such as shadows, weather, clothing, how full the school car park is, shop signs, plant behaviour</li> <li>• classify events into those that take more than, less than, about one half hour or 5 minutes</li> </ul>
Students have achieved Level 4 when they use the known size of familiar things to help make and improve estimates, including estimating centimetres, metres, kilograms, litres and minutes.	<ul style="list-style-type: none"> <li>• know the size of some familiar things and use them as benchmarks to help estimation; e.g. a litre carton of milk weighs about a kilogram</li> <li>• use the known length of body parts and movements to help estimate length; e.g. know their average stride is 90 centimetres and use this to estimate the length of the oval</li> <li>• use known time intervals as benchmarks to estimate quantities of time; e.g. <i>I take about 10 minutes to eat breakfast and I am sure the program ran longer than that.</i></li> </ul>	<ul style="list-style-type: none"> <li>• estimate, without the unit actually present, lengths and areas to about 4 or 5 metres or centimetres or square metres</li> <li>• estimate, without the unit actually present, which containers have capacity of about, less than, more than a litre and by hefting which objects have a mass of about, less than, more than a kilogram</li> <li>• use feedback from tests to improve estimates in centimetres, metres, kilograms and litres</li> </ul>
Students have achieved Level 5 when they make sensible estimates of length, area, mass, capacity and time in standard units and identify unreasonable estimates of things.	<ul style="list-style-type: none"> <li>• judge the size of common quantities; e.g. find lengths of about 1 millimetre, 1 centimetre, 1 metre; capacities of about 1 litre, 250 millilitres, 25 millilitres; areas of about 1 square centimetre, 1 square metre; masses of about 1 kilogram, 100 grams</li> <li>• unprompted, compare with known quantities to make standard unit estimates of length, capacity and mass; e.g. <i>The ceiling is about 3 metres high because the cupboard is about 1 metre and three would reach the ceiling.</i></li> </ul>	<ul style="list-style-type: none"> <li>• identify and use reference points for making and judging estimates; e.g. the dimensions and area of an A4 sheet of paper, Australia's yearly petrol consumption</li> <li>• unprompted, notice unrealistic 'measures' of familiar things; e.g. suggest that they may have made an error in calculation because a classmate is unlikely to weigh 5 kilograms</li> <li>• estimate time from starting and finishing times; e.g. decide if a 3-hour video will last from 11:35 p.m. to 2:50 a.m.</li> </ul>

## Key Understandings

Teachers will need to plan learning experiences that include and develop the following Key Understandings (KU), which underpin achievement of the outcome. The learning experiences should connect to students' current knowledge and understandings rather than to their year level.

Key Understanding	Stage of Primary Schooling— Major Emphasis	KU Description	Sample Learning Activities
<b>KU1</b> We can make judgments about order and size without actually measuring. We should think about how confident we can be of our estimate.	Beginning ✓✓ Middle ✓✓ Later ✓✓	page 72	Beginning, page 74 Middle, page 76 Later, page 78
<b>KU2</b> We can improve our estimates by getting to know the size of common units and by practising judging the size of things.	Beginning ✓✓ Middle ✓✓ Later ✓✓✓	page 80	Beginning, page 82 Middle, page 85 Later, page 88
<b>KU3</b> We can use information we know to make and improve estimates. This also helps us to judge whether measurements and results are reasonable.	Beginning ✓ Middle ✓✓ Later ✓✓✓	page 94	Beginning, page 96 Middle, page 97 Later, page 99
<b>Key</b> ✓✓✓ The development of this key understanding is a major focus of planned activities. ✓✓ The development of this key understanding is an important focus of planned activities. ✓ Some activities may be planned to introduce this Key Understanding, to consolidate it or to extend its application. The idea may also arise incidentally in conversations or routines that occur in the classroom.			

## KEY UNDERSTANDING 1

*We can make judgments about order and size without actually measuring. We should think about how confident we can be of our estimate.*

Being able to make judgments about order and size without measuring is helpful when actual measurement is difficult or we can tolerate reasonable variations in quantity. We use our perceptual judgment to estimate size, by looking at or feeling things, or experiencing the passage of time. While a person very familiar with a particular type of material might be able to look at something made from that material and estimate its mass or weight, it would not normally be sufficient simply to look in order to estimate mass; we would need to lift it. A student who tries to estimate the mass of a rock simply by looking at it may well be confusing mass with volume or with some other attribute.

Students should be encouraged to make statements about the confidence they hold in their estimates. A student might estimate a wall to be 7 metres wide but claim to be 'absolutely certain' that the wall is between 4 and 10 metres wide and 'pretty sure' it is between 6 and 8 metres. As they discuss their work, the language of approximation should be clarified (e.g. 'almost', 'not quite', 'a bit less than'). They should learn that the suitability of an estimate depends on how confident they would be to use it in particular circumstances. Thus, the suitability or 'correctness' of an estimate depends upon whether it is sensible for the use to which it is to be put and not how close it is to the 'real' measurement.

The focus of this Key Understanding is the development of the following understandings:

- It is possible to estimate a quantity by making a perceptual judgment (that is, by looking or feeling or experiencing).
- We may rely on perceptual judgments of quantity when making a direct physical measurement is difficult or impossible (perhaps we have lost our tape measure or the spot is awkward to get to).

- We may also rely on perceptual judgments of quantity when we are confident that our judgment is good enough for the circumstances.
- To be confident in our judgments, we need to attend to the right attribute and not be distracted by other perceptual features.
- We need to be able to say how confident we are of a particular estimate so we can decide whether it is good enough in the circumstances.

Key Understanding 2 deals with the development of students' skill in making perceptual estimates and Key Understanding 3 with their ability to improve and check estimates by supplementing perceptual judgments with known information.

Students who have achieved Level 1 will be prepared to make judgments of size in order to deal with familiar everyday matters. Thus, asked to collect a sheet of paper from the front of the room to cover their desktop, they will try to make a reasonable judgment of size.

Students who have achieved Level 2 will attend to the right attribute to make judgments in familiar situations, distinguishing length from area and mass from volume, although they may not consistently use this language. Thus, they will pick up the two things when asked which is heavier or how many of one will balance the other.

By Level 3, students do not let an overall sense of size (volume) distract them when estimating mass, and neither will they be distracted into thinking that the event that finished last (or started first) necessarily took longer. They understand the use of the language of 'between' to describe estimates and, prompted, will comment informally on their confidence in their estimates.

Students at Level 4 will say whether they have enough confidence in their estimate to rely on it in particular circumstances, although they may not think to take it into account unless prompted.

Students at Level 5 will do this unprompted.



## SAMPLE LEARNING ACTIVITIES

### Beginning ✓✓

#### Blanket for a Bear

Have students choose an area large enough for a purpose just by looking. For example, ask students to select a sheet of paper about the right size for a blanket to cover their bear (a wall space to display their work, a paddock for their collection of farm animals). Ask: Can you choose without taking your bear (your work, your collection of farm animals) with you? Draw out the idea that they can often tell by looking.

#### Sitting around a Hoop

Ask students to estimate how many of them could sit around a hoop. Invite them to check to see if they are close and then encourage them to modify their estimates. Repeat this with larger circles and other shapes. Focus on how confident they are in their estimates; (e.g. *I'm certain 10 could fit, and maybe even 15, but 20 would be too many.*) Ask: What did you look at to help you judge how many? Which part of the hoop did you look at? What did you think about when you were looking at the hoop?

#### Packing Away

While packing away equipment, ask students to estimate volume and capacity. For example, say: Choose a box that all the blocks or balls will fit into. Ask: Are you sure the long blocks will fit in that box? What about the smaller box? Why do you think the long blocks won't fit? Which boxes do you think will definitely not be big enough? What made you decide?

#### Odd Lids

Have students sort through a box of odd lids to find lids for particular containers. Encourage them to state their choices before testing them. Ask: What sorts of things tell you it should be the right lid? Do you think it will be too big or small? Do we need to try all of the lids on each container? Draw out the idea that looking backwards and forwards from the lid to the container can help us judge if it will be a close fit.

#### Balancing on the See-Saw

Have students estimate everyday objects by mass. For example, ask: Who could balance you on the see-saw? What is the heaviest thing you could carry in that tip truck without it tipping over? What could balance with that apple on the balance scales? Encourage students to explain their decisions. Ask: How could you decide which is heavier? Why is it hard to know which is heavier just by looking?

**Late Back**

Include students' judgments about time in oral stories. For example, say: Jason told the others, 'We'll all be late if we go to the other side of the oval because the bell will go before we get back.' Ask: How can you tell when the bell will go?

**Furthest Throw**

Have pairs of students estimate how far apart they should stand to play a game involving kicking or throwing a ball to each other. Encourage them to base their estimate on a previous day's experience of throwing or kicking a ball. Ask: How did you decide how far apart to stand? How can thinking about how far you kicked the ball yesterday help? How could pretending to throw a ball help you to think how far away your partner should be? (See Understand Units, Key Understandings 4 and 6, and Direct Measure, Key Understanding 3.)

**Choose a Rope**

Have students estimate to choose a length of rope to tie between two posts as a barrier for sports day. Lay out the ropes alongside each other far enough away from the posts to make direct comparison difficult. Say: It's too much effort to try all of these ropes, so pick out two lengths that you think are long enough to tie between the posts. Encourage students to first look at the gap then choose two ropes. After students have checked to see if their ropes fit, ask: What did you look at to help you choose a rope that was long enough? How did you know that rope would be too short? (Link to Understand Units, Key Understanding 2.)



## SAMPLE LEARNING ACTIVITIES

### Middle ✓✓

#### How Many People?

Invite students to estimate the room available for classroom activities. For example, ask: How many students will fit in the reading corner (the computer room)? How much room does one person need? How do you know that your estimate is close enough without moving people? Move the furniture to change the size of the space and ask again.

#### Display Board

Ask students to decide whether they need to measure or estimate in order to work out how many pieces of paper will fit on the display board. Ask: What will you look at to help you imagine how many fit across the board in one row? How many rows do you think will fit down the board? How sure are you that that many pieces of paper will fit? What would you need to do to measure how many do fit? Which would be easier—to measure or to estimate?

#### Estimate or Measure?

Have students consider different hypothetical situations where a judgment about mass is required and decide whether estimating or measuring would be appropriate. For example, say: It is winter and grapes are very expensive. Would you heft to estimate how much you wanted to buy, or would you want to check the mass on some scales before you bought them? Why? Why not?

#### Marking Out Games

Have students estimate to mark out games. For example, say: Let's mark out a hopscotch game. Ask: How will you judge the size for each shape? How long should it be altogether? How wide? Do you need to measure, or can you tell by just looking? Will it make a difference to the game? When setting up for cricket (tee ball), ask: How do you know this pitch is a reasonable size? When would we need to measure exactly?

#### Time before Recess

Invite students to judge if there is enough time left before recess (lunch) to play a game. Ask: How do you know how long it will take? How do you know how much time we have left? How can you estimate the amount of time left? How can you estimate the amount of time it will take to play the game? (past experience) (Link to Direct Measure, Key Understanding 6.)

#### Glasses of Cordial

Ask: How do you decide how much cordial to use when mixing a cordial drink? Why not measure out the amount? What happens if you use too much (not enough) cordial? What makes you feel sure you will have the right taste?

Have different students make up some glasses of cordial and compare the taste. Ask: Why is the taste different in the different glasses? What did you look at when you were pouring in the cordial? How did you know when to stop pouring? How could you make sure your glasses of cordial all had the same taste? (Link to Direct Measure, Key Understanding 1.)

### Covering a Tin

Ask students to estimate and choose the size of paper needed to cover the outside surface of a tin or jar to make a pencil holder. Invite them to test their estimate and, if necessary, choose another size. Ask: Why do you think you underestimated (overestimated) the size? Did you use the length (width) of the paper, or the area? Why? If you were using gold leaf paper, would an estimate be good enough? Why? Why not?

### Will It Fit?

Have students decide whether they can rely on an estimate to say if things are big enough (about the right size, not too big) for practical purposes (e.g. selecting a piece of wrapping paper to cover a present, cutting string to tie around a box, choosing a box to fit all the books in). Ask: Which part of the object are you looking at in order to make your decision?

### Distorted Estimates

Discuss factors that distort estimates (e.g. time passes slowly when you're waiting for someone, things look smaller and closer together when they're further away, a tall narrow glass looks like it would hold more than a short wide glass), including visual illusions (e.g. the shorter line below appears longer than the other, the person at the back of the room looks taller because the room has been drawn to perspective but the people haven't).

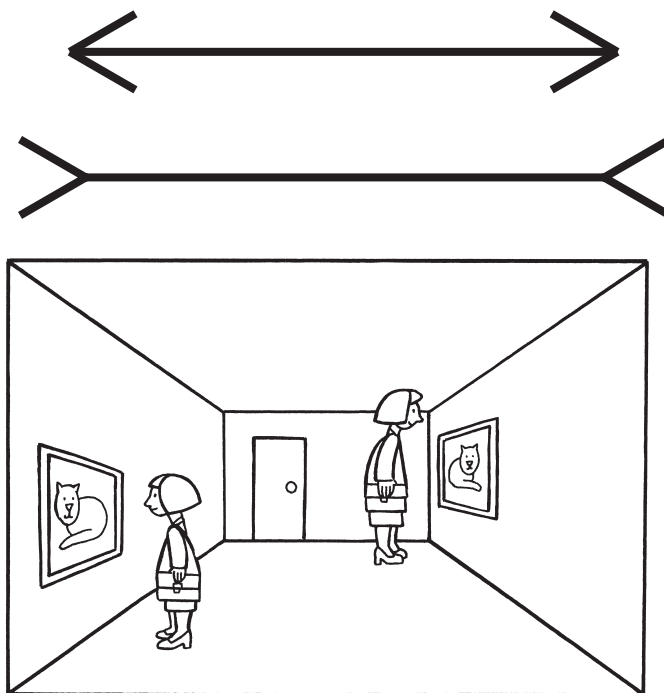

## SAMPLE LEARNING ACTIVITIES

### Later ✓✓

#### Sports Carnival

Have students decide how accurate measurements need to be for different purposes. For example, ask students to think about setting up the school oval for the sports carnival. They would need to decide:

- how many litres of oil they will need to mark out the running lanes
- what size each bay should be for each sports house or faction
- how much tape they will need to mark out the bays
- the position of the markers for team games.

Ask: Where might estimation rather than exact measurement be sufficient? What unit of measure would be accurate enough for each job? When do you need exact measures? (Link to Understand Units, Key Understanding 5.)

#### Bottles of Cordial

Ask students to decide how prepared they would be to rely on their estimates. For example, invite them to estimate how many litres of cordial are needed for every student to have a glass of cordial. Ask: If most estimates were about  $1\frac{1}{2}$  litres, how confident would you feel about buying one 2-litre bottle? What would you buy if the estimates were between  $1\frac{3}{4}$  litres and  $2\frac{1}{3}$  litres? Would it be better to over-estimate or under-estimate in this situation? Why? Is an estimate enough to decide or would an accurate measure be better?

#### Reasonable Estimates

Encourage students to use past experience to judge the reasonableness of each other's estimates. For example, say: Someone said they could walk around the oval in one minute. Do you think they could? What would be a more reasonable length of time? How do you know? (Link to Direct Measure, Key Understanding 6.)

#### Parent Panel

Have students invite parents to form a panel to answer students' questions about when they estimate and measure at work; for example, a builder might describe how and why the amount of mortar needed to lay bricks for a section of wall is estimated and why the placement of the first brick course is carefully measured to millimetre accuracy. Ask: Why is estimating chosen over measuring in some of the situations? In what kinds of situations is measuring important?

**Lift Problem**

Have students decide whether we might over-estimate or under-estimate in realistic situations. For example, say: The mass limit given on a lift is 905 kilograms. How many trips would it take to carry our class up to the ninth floor? Should we use our closest estimate, an over-estimate or an under-estimate of students' weight? (See Key Understanding 3; link to Indirect Measure, Key Understanding 4, and *First Steps in Mathematics: Number, Understand Operations*, Key Understandings 3 and 4.)

**Getting to the Bus Stop**

Have students decide when an under-estimate or over-estimate of time intervals is needed (e.g. getting to the bus stop, playing in the sun, cooking times for scones, travelling time to school). Ask: If I needed to get to the bus stop to catch the 10 a.m. bus, how much should I under-estimate or over-estimate the time it would take me to get there? Should I under-estimate or over-estimate the time I spend in the sun (the time it will take the scones to cook)? By how much? (Link to Direct Measure, Key Understanding 6.)



## KEY UNDERSTANDING 2

*We can improve our estimates by getting to know the size of common units and by practising judging the size of things.*

This Key Understanding deals with the improvement of students' skill in estimating quantities by making a perceptual judgment. We *look* at a man and say he is taller than Dad; we look at a jug and say it is big enough to hold two cups of sauce. We *heft* a rock and say it weighs a bit more than a kilogram, and we *experience* the passage of time and judge that at least ten minutes have passed. Students should understand that even though estimation relies on perception, it is not just guessing. Estimation involves judgment that has improved with the help of experience; that is, with practice.

Practice helps us to become both better at estimating quantities and more confident in our judgment, so that we are prepared to trust it. Helpful practice involves:

- making an estimate
- getting feedback on how close the estimate was (often by measuring immediately)
- consciously using the feedback to improve the next estimate, and repeating the cycle.

To estimate several things and then check the lot is less likely to improve our estimation skills. Sometimes, students misunderstand the request to 'estimate then measure' and develop the mistaken view that we would normally do both. They may then think that measuring is better than estimating, and even that an estimate is 'wrong' if it is not the same as the measurement.

Students should be clear that the reason we often measure after estimating in school is to get better at estimating, so they will not have to do both in future. In everyday use, we estimate *instead* of directly measuring. If we have faith that our estimation skills are sufficiently good for the situation, then we won't measure.

Students who have achieved Level 1 of the outcome will look to find something clearly longer than an object and heft to find something clearly heavier than an object.

At Level 2, students will generally be able to find lengths, weights or capacities of things that are 'about', 'less than' and 'more than' one provided. They will make reasonable length estimates up to about five or six units, if they can see and handle a representation of the unit, such as a rod or a pace.

At Level 3, students will also be able to find areas and times (to the hour, half hour and five minutes) that are 'about', 'less than' and 'more than' ones provided. They will make reasonable estimates of length, mass, area, volume or angle up to about six units, if they can see and handle a unit such as metre, litre and kilogram.

At Level 4, students use the known size of common things (e.g. a litre carton of milk) as benchmarks to assist them with their estimates. They also use the known size of common standard units, such as centimetre, metre, litre and kilogram, to find things of about that size without the unit actually present.

At Level 5, students have a well-developed sense of the size of common standard units and can find lengths of about 1 millimetre, 1 centimetre, 1 metre; capacities of about 1 litre, 250 millilitres (a cup), 25 millilitres (a tablespoon); masses of about 1 kilogram, 100 grams; and areas of about 1 square centimetre and 1 square metre.



## SAMPLE LEARNING ACTIVITIES

**Beginning** ✓✓**Animal Homes**

Have students find spaces large enough for one student to use as a 'home' in imaginative play. For example, provide boxes when students are pretending to be animals. Encourage students to try the space. Ask: Is it as big (small) as you thought? Invite some students to pretend to be animal families and look for 'homes' that will fit two, three or four students. Ask: How did you judge that box would be big enough for all three of you? What did you look at to make your decision? Use the same boxes repeatedly over a few days. Ask: which box fits two (four) people? How do you know?

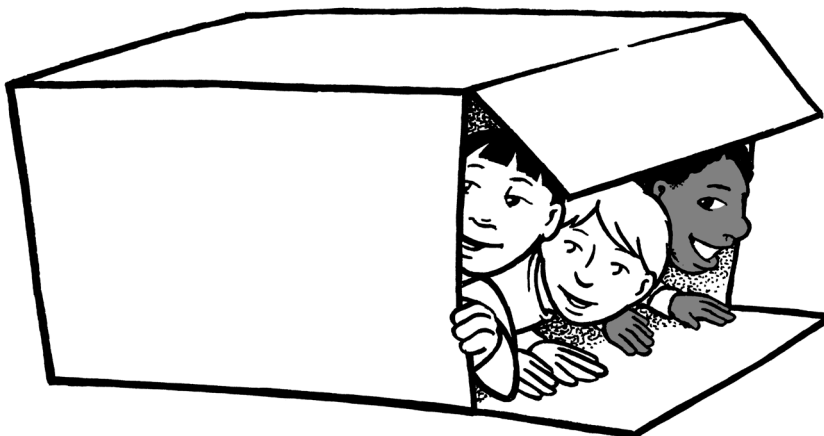
**Benchmark**

Have students stand in a circle. Ask one student to step forward and ask the others to find a student who is shorter (taller). After several goes, sit the class down, stand one student up and repeat the activity. Encourage students to visualise the heights of others. Try out each suggestion as it is given and let the student have another go to see if they can improve their estimate. Ask: What are you thinking about when you are trying to judge height? What difference does it make when you all sit down? Extend this to objects in the room by asking students to estimate which objects are taller than a selected object. (Link to Direct Measure, Key Understanding 1.)

**My Metre**

Invite students to find how far up their body a metre is. For example, say: A metre is up to my stomach. Where do you think a metre would come to on you? Ask them to practise imagining a metre high as well as a metre wide.

Ask: Is your bike seat more than 1 metre from the ground? Is your desk wider than a metre? Is the width of the doorway more or less than a metre? (See Key Understanding 3.)

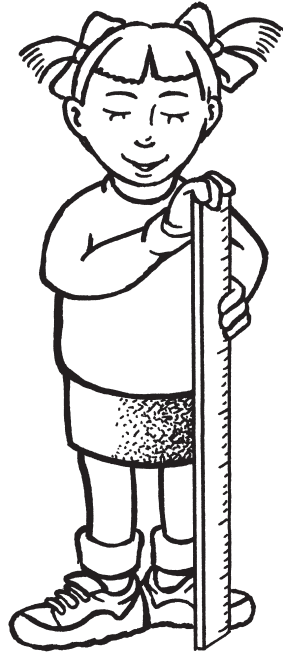

### Just a Minute

Ask: When someone says, 'Just a minute', how long do they mean? What activities do you think would take you about a minute? (e.g. putting on socks, getting a drink) Invite each student to try out their suggestions as they make them, telling them when to begin, then stopping them after a minute's duration. Encourage the class to use this information to suggest activities that are closer to a minute.

### Fingers and Thumbs

Give students pieces of card exactly 1 centimetre wide and ask them to find parts of their fingers and thumbs that are the same width as 1 centimetre. Ask them to estimate centimetre-sized lengths in the room and check with their 'benchmark'. Ask: What will happen to the size of your 'centimetre bit' when you get older?

### Minute Timer

Have students stand or sit with their backs to a one-minute egg timer or a one-minute rocker timer. Say: I am going to say 'Start!' when I set this one-minute timer going and I want you to put your hands on your head when you think a minute is up. Set the timer going and say: Start! Ring a bell to show when 1 minute is up. Ask: How close were you? Can you get closer? What did you think about to help you decide when the minute was up? Repeat to help students improve their estimates.

## Beginning ✓✓

### A Metre

Have students use a 1-metre length of card or string to find different things in the classroom that are close to 1 metre (e.g. the width of the bookcase, the height of the cupboard, the length of the desk). Have each student choose one of these to use as a benchmark for a metre length and estimate whether other lengths around the room are more than, the same as or less than a metre. Encourage them to check each time so that they can improve their estimates. Ask: What did you think about when you compared the length of your benchmark to the doorway? Why do you think you over-estimated (under-estimated) the length of a metre on your last go? (Link to Understand Units, Key Understanding 7.)

### Furniture through the Door

Ask students to decide which furniture will fit through the door so the room can be repainted. Encourage them to categorise the furniture into those pieces that will easily fit through, and those that will be close. Ask: What makes you sure that these will fit through easily? What makes you sure the other ones won't? Which pieces of furniture would you need to measure before you move them? Why?

### Vegetables and Fruit

Have students estimate a kilogram of various vegetables and fruits by comparing to a known kilogram benchmark. For example, select a common grocery item that weighs a kilogram (e.g. a litre of water, a kilogram can of fruit, a kilogram of yoghurt) and put it in a bag to use as a kilogram benchmark. Place various quantities of fruit or vegetables in plastic bags and invite students to heft to find those that match the mass of the benchmark bag. Encourage them to use a balance scale to check each time and thus improve their estimates. Ask: Why do you think different people made different judgments about which bags weighed 1 kilogram? Can you make up a bag yourself that you think contains a kilogram of potatoes? How does having the known kilogram bag help you? (Link to Understand Units, Key Understanding 7, and Direct Measure, Key Understanding 1.)

## SAMPLE LEARNING ACTIVITIES

### Middle ✓✓

#### Thumb and Forefinger

Have students practise holding their thumb and forefinger 1 centimetre (2 centimetres, 5 centimetres) apart and have their partners check with pieces of card cut exactly to each measurement. When they are able to do this with confidence, suggest they challenge family members to match their skill. Encourage students to use this visual memory to estimate the length of small items (e.g. an eraser, a pencil sharpener). (Link to Understand Units, Key Understanding 6.)

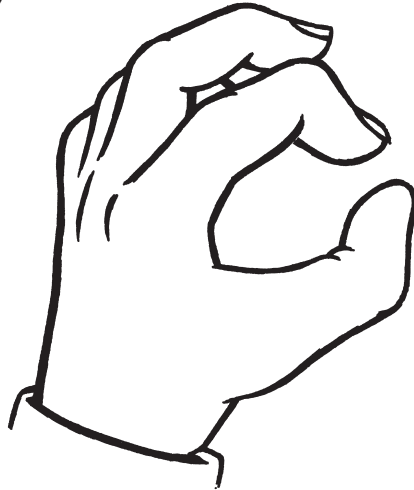

#### How Long Is a Metre?

Have students estimate metre lengths and distances and, with feedback, develop personal 'benchmarks' for the unit. For example, firstly, have students tear off a length of tape that they judge to be 1 metre long and then compare the tape to a metre tape measure. Invite students to try again, adjusting their next estimate according to their first result. Encourage them to use their outstretched arms in some way to help judge the metre length. Secondly, draw two chalk lines exactly one metre apart and have students step out the distance in various ways. Thirdly, have students use a metre rule to find a part of their body that is one metre above the ground. Ask them to estimate other heights of 1 metre and check with their 'personal benchmark'. Ask: How does checking your estimate help you get better at estimating a metre? How did working out a personal benchmark help improve your estimates? Why might you need to measure and check your personal benchmarks in six months or a year? (See Sample Lesson 1, page 91.)

## Middle ✓✓

### A Litre

Ask students to estimate a litre of water in a bucket, then pour it into a milk carton to check. Encourage them to try again, making adjustments, until the estimate is close to a litre. Then, invite students to estimate a litre of water in a large bowl, testing again with the litre carton. Ask: Why do you think your final bucket estimate was closer than the first bowl estimate? What were you looking at when you first estimated the litre of water in the bucket? How did you improve your estimate the second or third time? What did you think about when you were estimating the litre in the bowl? How could you estimate a litre of water pouring from the tap? (Link to Understand Units, Key Understanding 7.)

### Cans of Food

Have students heft to compare cans of various foods in different sizes with a known kilogram weight or object. Ask them to estimate the number of each type of can that would approximately equal a kilogram. Invite students to use balance scales to check results and try to improve at each attempt. Record and compare successive estimates. Ask: How did hefting the kilogram of jam help you to estimate how many cans of baked beans would weigh 1 kilogram? What did you think about to improve your estimate after you'd checked on the balance scales?

### Food at Home

Have students find things at home that are packaged in 1-kilogram amounts (e.g. 1 kilogram of rice, 1 kilogram of potatoes, 1 kilogram of sugar). Ask them to write about the size and feel of each package. Ask: How did the kilogram of potatoes feel different from the kilogram of rice? How would a kilogram of potato crisps feel the same or different from a kilogram of sugar? Later, bring in a range of similar packaged things that vary in weight between 250 grams and 2 kilograms and cover the weight information with stickers. Have students examine the packages and then heft them to identify which have a mass of about, less than, more than a kilogram. Ask: How did looking at the food help you decide which of the packages were about a kilogram? How did hefting help you choose the packages which were about a kilogram? (Link to Understand Units, Key Understanding 7.)

### A Square Metre

Have students join newspaper sheets to estimate and construct a metre square. Invite them to test their estimate by measuring the length of each side and then adding or removing paper until they have a square with sides of exactly 1 metre. Then, ask students to estimate which things in their environment would have an area of about a square metre by visualising a match with their newspaper square. Ask: How can you judge if its area is a

square metre if it is not a square? (imagine cutting up the newspaper square and rearranging it to fit the shape). What are you thinking of (looking at) to say that the long, narrow window is about 1 square metre? Can you imagine a circle that has an area of 1 square metre? Would it have to be wider or narrower than your newspaper square? Why?

### A Square Centimetre

Have students visualise how many square-centimetre tiles will cover the 'floor plan' of a room. Encourage them to look at a 1-centimetre square tile next to the plan and think of ways to judge how many would be needed. Invite them to compare methods, then estimate again using a different 'floor plan'. Ask: Did your strategy change after your first try? How? Were you more confident in your estimate the second time? Why? Why not?

### Egg Timer Estimates

Have students make an 'egg timer' with two plastic bottles and help them to adjust it to measure exactly 5 minutes. Organise students into pairs and ask them to take turns practising estimating 5-minute intervals while their partner checks using the timer. Ask: How close was your estimate? Can you get closer with practice? Does what you are doing during the 5 minutes affect how accurate your estimates are? (See Direct Measure, Key Understanding 6, for more detail.)

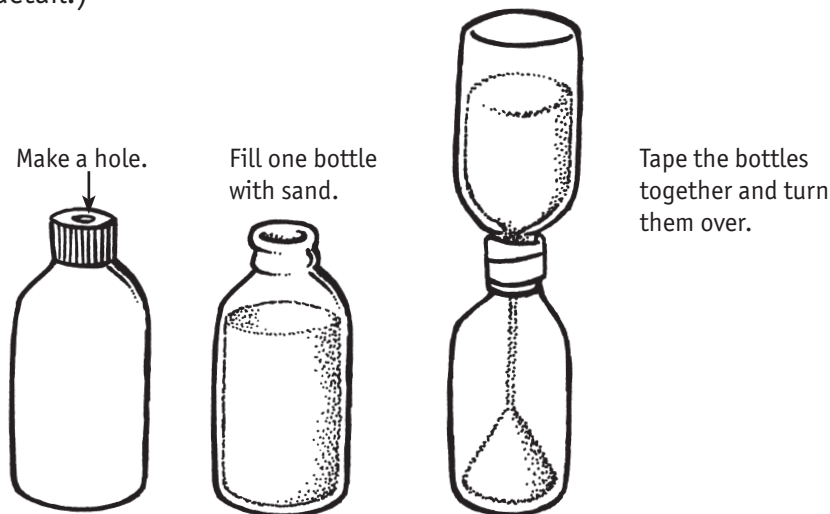

### Standard Volumes

Give students 1-litre drink bottles or milk cartons to use as a benchmark to help them estimate the volume of liquids. Have students pour water into and out of the litre container to help them visualise the amount of liquid in a litre. Invite students to decide whether other amounts of liquid are less than, close to, or more than a litre (e.g. a glass of milk, the amount of water needed to water an indoor plant). Ask: What helped you judge that the glass of milk must be less than a litre? (Link to Understand Units, Key Understanding 7.)

## SAMPLE LEARNING ACTIVITIES

### Later ✓✓✓

#### Class Charts

Have students make class charts naming familiar objects that are approximately 1 gram, 1 kilogram, 1 centimetre, 1 metre, 1 millimetre, 1 litre. During classroom activities, encourage students to use the charts to help them estimate other things. For example, say: If you know that bag of rice weighs a kilogram, how heavy do you think that bag of potatoes is? (Link to Understand Units, Key Understanding 7.)

#### Length of Pace

Have students develop their own reliable personal 'benchmarks' in order to improve the accuracy of their estimations. For example, ask students to find the average length of their normal walking pace, then the length of different types of paces (e.g. striding, jogging, running). Ask: Which types of paces could you use to estimate metres? How reliable would your estimates be using the different paces? Encourage students to choose a pace type to use as their 'benchmark', and use it to estimate a 10-metre distance, a 25-metre distance and a 50-metre distance. Have their partner check with a trundle wheel to give feedback on the usefulness of the method. (Link to Understand Units, Key Understanding 5, and Indirect Measure, Key Understanding 4.)

#### Box for a Toy

Have students visualise and estimate the size of familiar objects they can't actually see to measure. For example, say: Think of a small toy or object you have at home and estimate its dimensions to construct a box for it. All the boxes will be placed in a large container to be sent overseas, so save as much space as you can. When students have made their boxes, ask them to bring in the objects from home and test them in their boxes. Ask: How well did your container match the size of your objects? Why do you think you over-estimated (under-estimated)? How could you improve your judgment in the future?

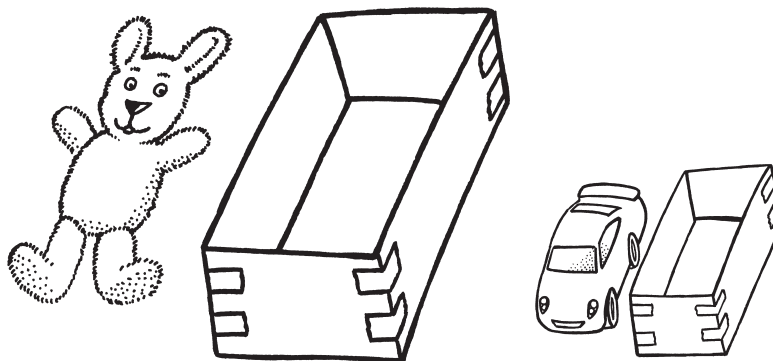

### Bags of Mass

Have students improve their estimation of mass units. For example, provide plastic bags marked with a range of masses such as 100 grams, 250 grams, 500 grams, 800 grams and 1000 grams. Invite students to choose from substances such as rice, beans, sand or play dough and place what they estimate to be the appropriate mass in a selected bag. Encourage them to check the mass on a kitchen scale and to repeat with the same substance until they get close to the target mass. Invite them to try another mass. Ask: How did you judge 250 grams of rice? How was this different from 250 grams of play dough? How would you estimate 250 grams of rice crisps? (Link to Understand Units, Key Understanding 7.)

### Feedback on Distance

Have students consider the value of different types of feedback for improving estimates. For example, ask students to pace out either 7 metres, 9 metres, 11 metres or 13 metres, then have their partner measure with a trundle wheel and use one of the following four types of feedback:

- 'right', 'wrong'
- 'way out', 'a bit out', 'close'
- 'much (a little) too long', 'much (a little) too short'
- say the actual distance in metres.

Have students repeat the estimate, measure and feedback cycle five times, then choose a different distance and feedback type and repeat the process, with their partners keeping a record of the actual distance paced out each time. Invite students to decide on the type of feedback that best helps improve successive estimates. Ask: Which types of feedback were the most (least) helpful for improving your estimates? Why? (Link to Understand Units, Key Understanding 7.)

### More Feedback

Extend 'Feedback on Distance' to other attributes, such as mass, liquid volume, time and angle, to have students find which kind of feedback best helps improve their estimates.

### Sorting Shapes and Surfaces

Extend Later Sample Learning Activity 'Covering One Square Metre' (Direct Measure, Key Understanding 5) by having students sort a range of shapes or surfaces according to their estimate of whether they are less than, more than or about equal to one square metre. Include a range of sizes of circles, triangles, rectangles and other irregular shapes cut out from butcher's paper or drawn in chalk on the playground. Ask: How did you judge that the triangle was larger than a square metre? How did you imagine cutting and rearranging the narrow rectangle to match a square metre? Is there a different way you can think about visualising that amount of area?



## Later ✓✓✓

### Length Benchmarks

Have students use a ruler to measure various parts of their hand and forearm to find a reliable personal benchmark for a millimetre, a centimetre and a decimetre. Invite students to challenge partners to use a straight edge to draw lines with lengths between 1 millimetre and 30 centimetres as accurately as possible using only their benchmarks to help them. Ask: Which combination of benchmarks did you use to draw your line 12.5 centimetres long? How did you judge the half centimetre? Can you find a more reliable benchmark?

### Milk Cartons and Mass

Have students fill a milk carton with water and weigh it to determine that a litre of water has a mass of 1 kilogram. Ask them to use that information and a medicine glass to find amounts of water that weigh various small numbers of grams. Then, invite them to pour the amounts of water into small lightweight plastic sandwich bags and heft to gain a sense of the mass of small quantities of water. Encourage them to use hefting to estimate the mass of small objects (e.g. pencils, rubbers, pencil sharpeners, seeds, small pebbles). Ask: What is the smallest number of grams that you can reliably estimate? Can you tell the difference between 5 grams and 10 grams? Why do you think it is so difficult to estimate the mass of very small objects by hefting, compared to estimating mass in kilograms?

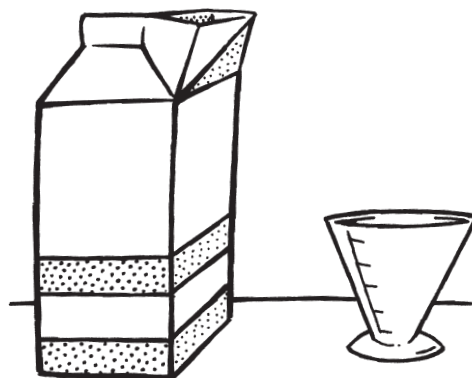

### Milk Cartons and Volume

Help students establish that 1 litre is the same volume as 1000 cubic centimetres, or 1 cubic decimetre. Invite students to estimate the volume of various objects by imagining a milk carton and comparing its dimensions to the size of the object. For example, *I think the volume of the softball would be close to a cubic decimetre, because I can imagine that if it was made out of play dough, I could make it into the size and shape of a milk carton.* Ask: How could you estimate smaller volumes by thinking about smaller milk or juice cartons?

## SAMPLE LESSON 1

**Sample Learning Activity:** Middle—‘How Long Is a Metre?’, page 85

**Key Understanding 2:** We can improve our estimates by getting to know the size of common units and by practising judging the size of things.

**Working Towards:** Levels 2 and 3

### Teacher’s Purpose

My Year 3 students had often used a trundle wheel to measure outdoor distances in metres and a metre rule to measure the width of things in the classroom. When I asked them to estimate the distance to the canteen in metres, however, they all simply counted the steps they took. So I decided to set up some activities to help them develop personal benchmarks for a metre.

### Action and Reflection

I gave the students rolls of paper tape and asked them to tear off a strip that they estimated to be a metre long, and write their name clearly on it. We then pinned the strips to a display board, lining up one end. I asked the students to write down whose tape they thought would be closest to a metre and then pinned a metre tape measure above the strips and drew a line down from the metre point across the tapes.

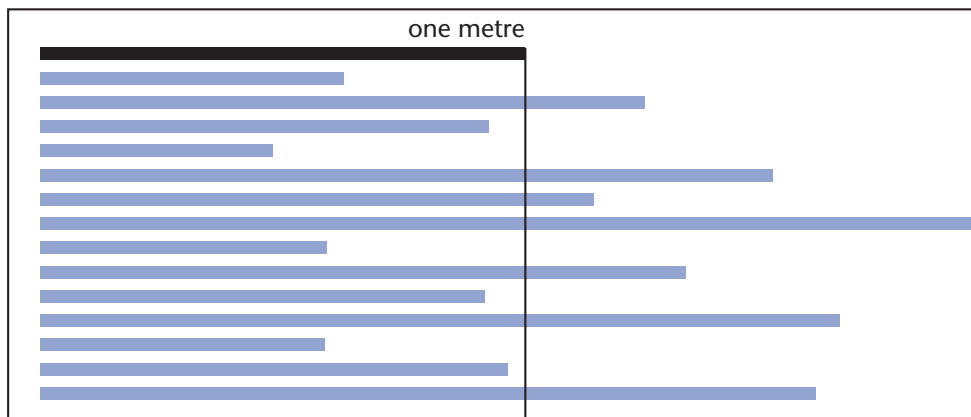

The students looked at and commented on their estimates.

‘Oh, mine was much too little.’

‘Mine is about two metres long.’

‘Look, mine’s just about the same as Lian’s and only a little bit less than a metre.’

## Opportunity to Learn

I then asked them to have another go at tearing off a metre of tape. Each new strip was pinned on top of the old strip and we compared the new estimates to the metre. Most had overcompensated in their second attempt—if their first estimate was shorter than a metre, their second was much longer than a metre, and vice versa.

Several wanted to try a third time and I asked what they thought they might do to make it a better estimate.

‘The first one I just kept unwinding until I thought it must be a metre, but it turned out really, really long. The next one I looked at the tape and thought if it looked like the one on the wall, but it ended up too short. This time I’m just going to try and look at it and think it’s a bit longer than the wall one,’ said Choon.

Maria said, ‘I just guessed the first ones, but this time I’m going to put out my arms and “think it”.’

## Connection and Challenge

After Maria’s comment, I told the students how I estimate a metre of fabric or ribbon. I hold one end with the fingertips of one hand and, with my other hand, stretch it to the tip of my nose with my head turned away.

The students were very interested to watch me tear off a strip of tape using my method, and they were most impressed to see the tape was so close to a metre when tested.

The students were then anxious to try again for themselves, and this time I was pleased to see that most made some sort of physical estimate, and I was able to encourage them to keep trying until they found a way to match a metre.



When students became confident that they had a personal benchmark for estimating a metre, I asked them to go outside and each draw two chalk marks on the playground that they thought were one metre apart.

I was surprised to find that in this different context most were unable to use the method they'd previously developed and simply took a step, or reverted to guessing. When they paired up to test each other's estimate with a trundle wheel, they were perplexed to see how different their metres were. Several of the students who had taken one step and measured that, were surprised that a metre was so much longer. Sam even accused his partner of turning the wheel twice—he had difficulty believing that the circumference was so much longer than the diameter of the trundle wheel.

I realised that estimating distance was more complicated because they needed to think about some imaginary straight line running between the two chalk marks, then mentally measure this.

I then asked students to find one of the metre paper tapes they had previously estimated with some accuracy and compare this to the distance they'd marked out, and to the trundle wheel.

### **Drawing Out the Mathematical Idea**

This provided an opportunity to talk about the different things they had to think about when estimating a metre in situations where there was no line or edge to guide them.

To help them develop a way to pace out a metre length, I drew two lines across the verandah exactly 1 metre apart, close to our door. Students enjoyed using this guide to find their own way to reliably judge a distance of one metre.

After several days, I again asked students to estimate a metre distance in the playground and found most had developed some way to approximate this very well.

### KEY UNDERSTANDING 3

*We can use information we know to make and improve estimates. This also helps us to judge whether measurements and results are reasonable.*

This Key Understanding deals with the development of students' ability to supplement their perceptual judgments with known information in order to make or improve estimates and judge the reasonableness of estimates and measurements made by others.

There are a variety of ways in which known information might be built into an estimate.

- Students could make a direct perceptual comparison with something they know the size of; for example, they could estimate the mass of an object by holding it in one hand and holding one or more 50-gram chocolates in the other.
- Students could use something they know the size of as a measuring instrument by 'marking off'; for example, they could mark off hand spans across a table, and use their knowledge of the length of the hand span and a calculation to estimate the table width in centimetres.
- Students could use ratios or fractions to estimate the size of small things; for example, they could weigh a ream of paper and use it to estimate the weight of one sheet of paper.
- Students could pool a combination of known information and 'good guesses' to estimate quantities without collecting actual data; for example, they could work collaboratively to estimate the quantity of water used in their school each day or the number of kilometres they walk each week.
- Students could average a number of estimates to get an improved estimate; for example, they could average class members' estimates of the same span of time.
- Students could use common events to estimate amount of time and time of day; for example, they could use how busy the car park is to estimate how long it is to the end of the school day.

Students should also learn to call upon sizes they already know or to reason on the basis of familiar or known quantities to judge the reasonableness of a result; for example, could the bread really weigh 3.4 kilograms, or the average height of women in Australia really be 217 centimetres?

Students at Level 3 can identify body parts of about 1 centimetre, 10 centimetres and 1 metre and use these directly to make estimates of length. They can also build given information into their judgments; being told that the door is 2 metres high, they will say that the ceiling is about half as much again, so it is about 3 metres high. They will say that since the lunch break is 40 minutes and the concert fitted well within the lunch break, it can't have lasted more than 30 minutes.

Students at Level 4 recall the size of some body parts and movements (e.g. hand span, finger width, arm length, pace) and use these and simple calculations to make estimates (e.g. *My pace is about 90 centimetres and the garden is 24 paces long so ...*). They collaborate with others to develop strategies for making sensible estimates of quantities, such as how much water is lost from dripping taps each week at school.

At Level 5, students have a repertoire of 'reference points', such as the size of A4 paper, and, unprompted, they build these into their estimates and their judgments about the reasonableness of measurements.

## SAMPLE LEARNING ACTIVITIES

### Beginning ✓

#### Using Known Measurements

Encourage students to use known lengths (volumes, masses) of objects to estimate other lengths (volumes, masses). For example, invite them to use something that just fits in their bag as a guide to decide if something else will fit without having to get the bag. Ask: You know that big thick book will fit into your bag, so do you think your diorama will fit without squashing it? How did you decide? Or, ask them to establish how many popsticks fit along their desk, then look at the length of the bookshelf and decide if it is more or fewer popsticks wide. Ask: How many popsticks long do you think the bookcase might be? How did you decide? (Link to Key Understanding 1.)

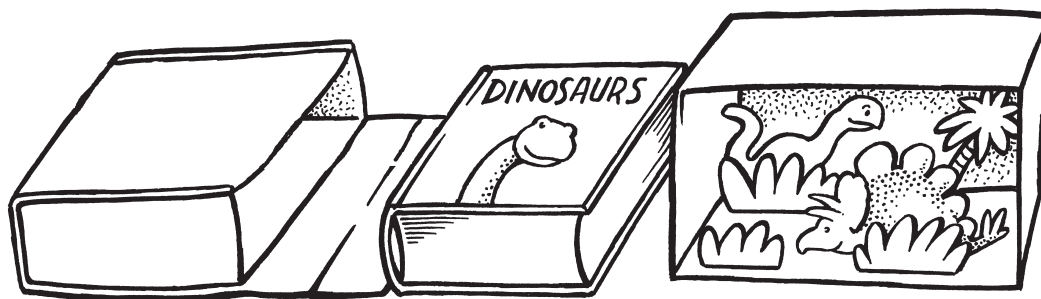

#### My Metre

Extend Beginning Sample Learning Activity 'My Metre' in Key Understanding 2 by having students use their knowledge of a metre in relation to their body length to judge heights. For example, ask them to use their knowledge of where a metre comes to on their body to decide if heights in the playground are more than a metre or less than a metre. Ask: How can you tell that the monkey bars are more than a metre from the ground? Do you think that the coat hook is higher than a metre from the floor? How can you tell?

## SAMPLE LEARNING ACTIVITIES

### Middle ✓✓

#### Wanted

After measurement activities that establish the heights of students in the class, present a 'wanted' poster with a description that includes the height of a 'wanted' person. Have students identify possible 'wanted' persons from other classes by estimating their heights based on their own height and the known heights of others in the class. For example, *The wanted person is 20 centimetres taller than me. I know that Katie is 10 centimetres taller than me and Ian from next door looks about 10 centimetres taller than Katie, so Ian could be the one.*

#### Estimating with Heights

Have students use what they know about their height to estimate other lengths (e.g. the height of the door, the height of the window, the length of the room). Ask: How did you decide that the door is twice your height? Can you visualise how many of you would fit lying head-to-toe along the wall?

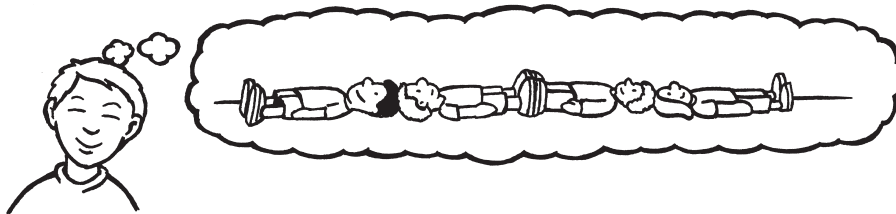

#### Smallest to Largest Capacity

Have students compare a variety of cups with a standard measuring cup (250 millilitres), estimating to line them up from the smallest to largest capacity. Ask them to measure to find how many millilitres each one holds and order them again. Invite students to look at other liquid containers and say whether they hold more or less than 250 millilitres or about how many millilitres they hold. Discuss strategies for making the comparison. Ask: How does the shape of the container affect your estimate? How can visualising changes in shape help you to compare the container to the measuring cup? (Link to Understand Units, Key Understanding 7.)

#### Orange Juice for Lunch

Extend 'Smallest to Largest Capacity' to estimating quantities of liquid for real purposes. For example, ask: How much orange juice would we need for a class lunch? Would 10 litres be a sensible estimate? How could you decide from what you know about the capacity of a cup and 1 litre? (Link to Indirect Measure, Key Understanding 4.)



## Middle ✓✓

### Fish Sizes

Have students use parts of their body as benchmarks for practical estimation. For example, display a local fisheries chart showing minimum sizes. Ask students to work out personal 'benchmarks' for the minimum sizes of a range of local seafood (e.g. whiting, tailor, crabs, prawns). Give groups of students different-sized cardboard cut outs of the fish so that they can use their 'benchmarks' to judge which they can keep and which must be thrown back. Appoint one member of each group to be a 'Fishery Inspector' and check with a ruler if any under-size fish have been kept. Have students refine their benchmarks and try again to improve their estimates.

### The Length of the Oval

Have students use measurements they know to judge the reasonableness of estimates. For example, say: Someone told me the length of the oval was 200 metres, but I'm not sure. Ask: How close do you think this estimate might be? How do you know? Encourage students to identify a known 10-metre length from which to judge the claim. For example, *I know I can throw the beanbag about 10 metres, and it takes about five throws to cross the oval. Or, I can see that the oval is not much more than twice its width, so 200 metres is too much. I think it is only about 120 metres.*

### Capacities

Have students make use of capacity measures of smaller quantities to estimate large amounts. For example, ask: How much water do you think we'll need to refill the fish tank? Think about the capacity of other containers that you already know about, like 2-litre ice cream containers or 2-litre orange juice containers. How could that help you estimate? (See Sample Lesson 2, page 102.)

### Time Schedule

Have students use estimation to work out a time schedule for an excursion. By comparison to known or measured time intervals (e.g. how long it takes to eat lunch, get a drink of water, get to swimming lessons by bus), determine how long is needed for the bus trip, how long for lunch, how long to see the display (do the activity) and so on. For example, ask: If it takes about 15 minutes in the bus to get to the pool for swimming lessons and the museum is twice as far away, how long should we allow for the bus trip? Say: It takes about 15 minutes to eat lunch at school and about 15 minutes to get a drink. Ask: How long do we need to allow to get out of the bus and find a place to sit? So, how long do we need for lunch altogether? (Link to Indirect Measure, Key Understanding 4.)

## SAMPLE LEARNING ACTIVITIES

### Later ✓✓✓

#### Marking off Lengths

Have students use the idea of marking off to estimate a short length from a known long length. For example, say: This bolt is 20 centimetres long. Estimate the length of this shorter bolt. How does knowing that the short bolt fits along the long bolt about four times help you estimate the length of the short bolt? (Link to Indirect Measure, Key Understanding 4, and *First Steps in Mathematics: Number*, Understand Operations, Key Understanding 4.)

#### Water Used in the School

Have students combine measuring and estimation to solve complex problems. For example, ask them to estimate how much water the school uses in a day. Encourage students to think about what to measure and what to estimate. Stimulate thinking with questions like: How many students are there in the school? How often do they have a drink of water? How can we decide how much one student drinks? How much is it likely to vary? What other ways is water used in the school? Encourage students to consider other sources of information that could help them (e.g. the water authority, the cleaners, the gardener, the canteen manager). (Link to Indirect Measure, Key Understanding 4, and *First Steps in Mathematics: Number*, Understand Operations, Key Understandings 3 and 4.)

#### A Kilometre

Have students develop personal benchmarks for a kilometre by using a local map to identify a familiar landmark that is a kilometre away from their homes. Ask them to estimate the distance from the school to various destinations based on what they know is a 1-kilometre distance from their home. Then ask them to plan a 5-kilometre jogging circuit around the district, using estimation to judge the appropriate distance. (Link to Indirect Measure, Key Understanding 3.)

#### Carpeting the Classroom

Have students use their known height to estimate area. For example, say: The carpet shop has a special on 12 square metres of carpet. Is this enough for our room? Invite students to say how long and wide the room is using 'body lengths' and use what they know about their height to say if this is enough carpet. Ask: Did visualising how many times your body length fits the length and width of the room help you estimate how many square metres the room is? How? Can you draw a diagram to show how it helped? (Link to Indirect Measure, Key Understanding 1.)

## Later ✓✓✓

### Volume of the Classroom

Ask students to estimate in a variety of situations where they do not have access to the measuring unit. For example, invite them to use the image of a metre cube to estimate the volume of the classroom. Ask: Can you use your hands to help you visualise the width and height of a metre cube? Can you imagine how many you would stack to reach the ceiling and how many would fit side-by-side along the wall? How would that help us estimate how many would fill the room? Construct the skeleton of a 1-metre cube using rolled newspaper. Ask students to imagine how many cubes would cover the floor and how many would stack to reach the ceiling. Compare this result to their initial estimations. Ask: What have you learned that you can use when you estimate the volume of the storeroom? (Link to Indirect Measure, Key Understanding 4, and *First Steps in Mathematics: Number*, Understand Operations, Key Understanding 3.)

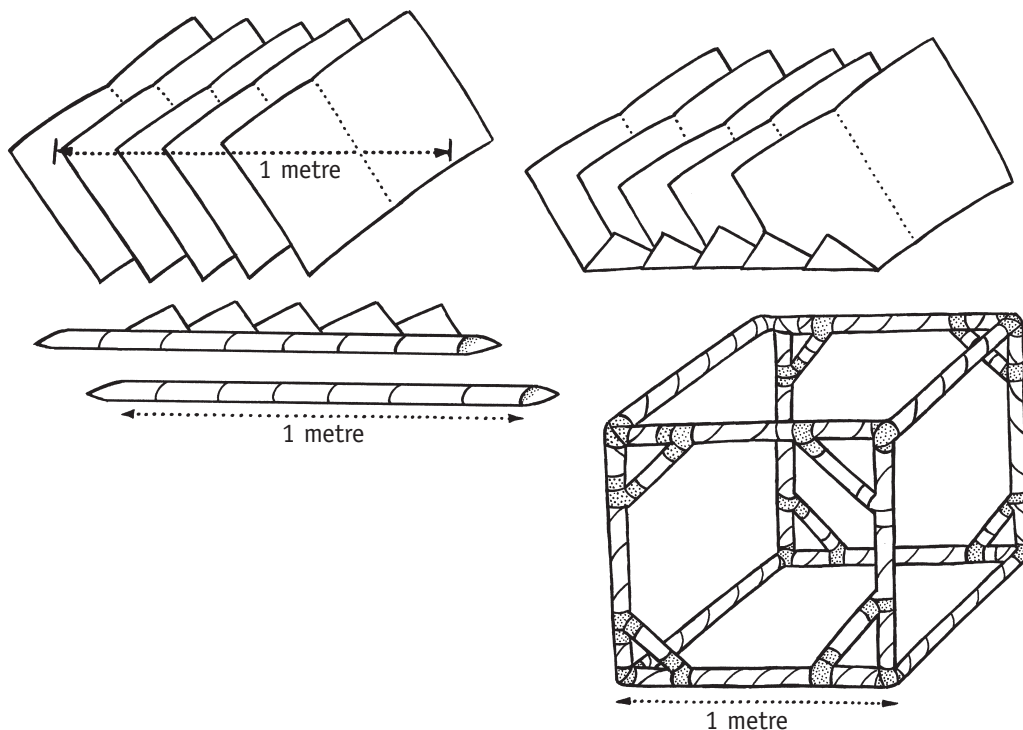

### Cubes and Litres

Extend 'Volume of the Classroom' by having students estimate the amount of water in a swimming pool. Help students use the connection between litres and cubic decimetres (see Did You Know? Understand Units page 90) to establish that 1000 litres is equal in volume to a cubic metre. Encourage students to look at their 1-metre cube and use the kind of thinking that helped them estimate the volume of the room to estimate the number of litres of water in the pool. Ask: How would imagining how many cubes would stack together to fill the pool help you estimate the volume of water in the pool?

### Eye Level

Encourage students to use known lengths of body parts to help estimate lengths. For example, invite them to measure their eye level from the floor and use this information together with the image of their ruler to estimate the heights of other people and things. (e.g. *My eye level is 126 centimetres and when I'm looking straight ahead at you I see the tip of your nose. I think from there to the top of your head is about two thirds of my ruler; that's 20 centimetres, so I think you'd be close to 146 centimetres tall.*)

Invite students to test their estimates against actual measurements. (Link Indirect Measure, Key Understanding 4, and **First Steps in Mathematics: Number**, Understand Operations, Key Understanding 1.)

### Marking off Cupfuls

Invite students to mark off cupfuls of liquid in order to select the container that will hold the most from several different-shaped containers. Encourage them to put one cup of water in each container and place a mark at that level. Then, have them use the one-cup level to estimate how many more cups would fit in each container by visualising each extra cup level. Use this information to express the capacity of each container as a range (e.g. between 6 and 7 cups). Ask: How does the shape of the container affect your estimates? What happens to the height of each level when the container gets wider?

### Capacities

Extend 'Marking off Cupfuls' to estimating the capacities of larger containers (e.g. fish tanks, water cooler bottles, large flagons). For example, pour a 10-litre bucketful of water into a fish tank and ask students to visualise the levels of water that further bucketfuls would reach. Ask: How can we use the level of the first bucketful to estimate the total? Why not just put in one litre of water and judge from that? (See Sample Lesson 2, page 102.)

### Inaccessible Lengths

Extend the marking off idea to estimate a long inaccessible length from a short length (e.g. height of trees, height of tall buildings, length of a ship). For example, give students a photograph of a person standing next to a building and invite them to visualise and mark off the 'man heights' on the side of the building. Use the known height of the person or the approximate height of people to estimate the height of the building. (Link to Indirect Measure, Key Understanding 4, and **First Steps in Mathematics: Number**, Understand Operations, Key Understanding 3.)

## SAMPLE LESSON 2

**Sample Learning Activity:** Later—‘Capacities’, page 101

**Key Understanding 3:** We can use information we know to make and improve estimates. This helps us to judge whether measurements and results are reasonable.

**Working Towards:** Levels 3 and 4

### Teacher’s Purpose

The fish tank in my Year 6 class needed to be cleaned. To decide how much conditioner to add to the water, we needed to know the approximate capacity. I decided to use this to help students think about how they could use the known capacity of other containers to estimate unknown quantities.

### Motivation and Purpose

I asked everyone to try estimating the quantity of water needed and record this in their maths journal. Their estimates varied from 50 to 200 millilitres and from 1 to 5 litres, which suggested that most students had little sense of the size of the units and were simply guessing.

### Opportunity to Learn

I was certain all had experience of a litre carton of milk, a 2-litre bottle of soft-drink and smaller fruit juice cartons measured in millilitres, and I knew some students could quite accurately name the capacity of many of these common containers. But they seemed not to have considered comparing the size of these known containers to the fish tank. For example, Katie said, ‘It would hold heaps. I reckon a hundred mils [*sic*].’

I asked them to bring a range of liquid containers from home and we sorted them from the smallest to the largest capacity.

### Action and Reflection

The students noticed that some different-shaped containers held the same amounts. ‘The small ice-cream container and the milk carton are both one litre. I thought that the milk carton was bigger, but they’re the same,’ remarked Dion.

We then used the litre containers to find the capacity of other containers. During these activities, we discovered that our plastic buckets held 10 litres

*Though students can become very good at recognising particular sized millilitre and litre containers in common use, they do not consciously make comparisons between them, nor do they often have strategies for using known volumes to judge the capacity of less familiar containers. They need help to make such connections.*

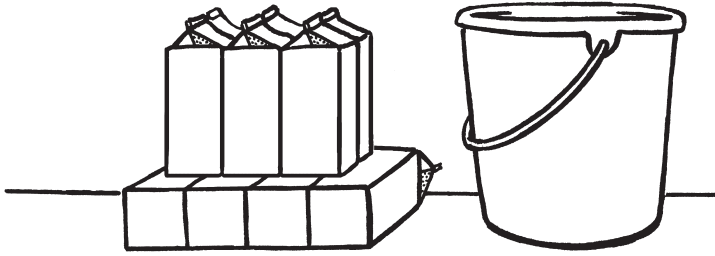

and we also stacked ten milk cartons next to a bucket to see that it did look to be about the same amount, even though it was a different shape.

I then asked the students to go back to their estimates of the fish tank to see if they still thought their estimate was reasonable. All rejected their first estimate and were very keen to make another, more informed one.

With very little prompting, most used what they'd learnt about the capacity of a bucket to make more sensible estimates.

This is an example from Katie's maths journal:

*I first of all said that the fish tank would hold 100 mL because I thought a hundred was a lot. But 100 mL is not even a little chocolate milk carton. I think it would hold about 20 litres because you can see it's bigger than a bucket and a bucket is 10 litres.*

Aaron wrote:

*It had to be more than 5 litres because that's just half a bucket and the fish tank's much bigger than that. I reckon you'd have to tip in about 5 buckets of water to fill it so I think it would hold about 50 litres of water.*

### Connection and Challenge

I then asked the class what we could do to be more confident about our estimates without filling the fish tank and measuring exactly how much water we used.

Matthew suggested, 'Why don't you just pour one bucket in? We could see how high that goes up and look and think how many more buckets would go in.'

Rebecca remembered the pile of milk cartons we compared with the bucket and said, 'We could get some empty milk cartons and stack them to work out how many would be about the same size as the fish tank.'

We worked on Matthew's suggestion and, after the first bucketful went in, he used his fingers to mark the levels he visualised for each bucketful.

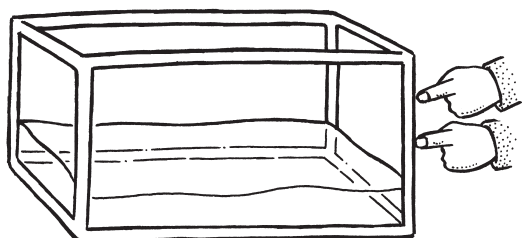

I asked if anyone thought they could make a closer estimate than between 30 and 40 litres. Jeremy suggested that it was between 30 and 35 litres because, 'It doesn't look like any more than half a bucket more would go in.'

Kira added, 'But it doesn't look like it could be much less than half a bucket either, so it's more like 35 than 30 litres.'

We then moved on to Rebecca's suggestion. Although she had originally intended that we actually build a pile of milk cartons in the shape of a fish tank, we now realised we would not have enough cartons in the classroom for this, and we didn't really need to do all that work. Instead, I helped students visualise that eight cartons on their side would cover the base of the tank and then four layers would bring this nearly to the height of the tank, arriving at an estimate of 32 litres. Students were delighted that the two estimates were so similar, and could see that the difference could be accounted for by the fact that four layers of milk cartons would be a little short of the full depth. Because we would not be filling the fish tank right to the top, we decided to use the lower estimate to calculate the quantity of conditioner needed.

### Drawing Out the Mathematical Idea

I thought that students were now beginning to understand that making reasonable estimates was not about making lucky guesses, but often requires them to use some careful reflection and a procedure to compare the quantity to be estimated to an appropriate 'benchmark'. I asked them to take a few minutes to write in their journals what you need to know and do to make good estimates. Their responses suggested they had grasped the main idea, for example:

*You can't just guess, you have to have something that you know about in your brain and think about how that fits in with what you want to estimate. You think out how many fit in and then you times it.*

*Like you might want to think how much water and in your mind you look at how many milk cartons would fit in, or how many buckets because you know how much is a milk carton or a bucket, and then you can figure it out.*

Classroom Plan for Week \_\_, Term \_\_, Year Level: \_\_

Outcome/Key Understanding	Mathematical Focus	Activities	Focus Questions	Observations/Anecdotes



## Bibliography

Battista, M. 1999, The importance of spatial structuring in geometric reasoning, *Teaching Children Mathematics*, November, 170–177.

Messenger, N., and Southey, R. 1998, *The Three Bears*, Dorling Kindersley, London.